



# Optički davači (interfejsi) – Sadržaj

---

- Vrste
- Primjena
- Enkoderi – davači položaja

# Optički senzori se po načinu funkcionisanja realizuju kao:

- **Transmisioni** (prolazni) senzori
- **Refleksioni** (odbijajući) senzori
  - refleksija=odbijanje, odražavanje
- **Difuzioni senzori**
  - difuzija=rasipanje, širenje, razlivanje
- **Distance-settable Sensors** (Senzori za procjenu rastojanja objekta)
- **Limited-reflective Sensors** (Senzori ograničene refleksije)

# Prolazni (transmisioni ili thru beam) davač

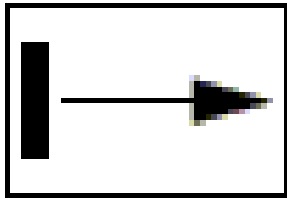

predajnik

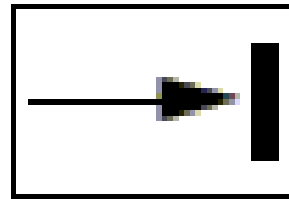

prijemnik

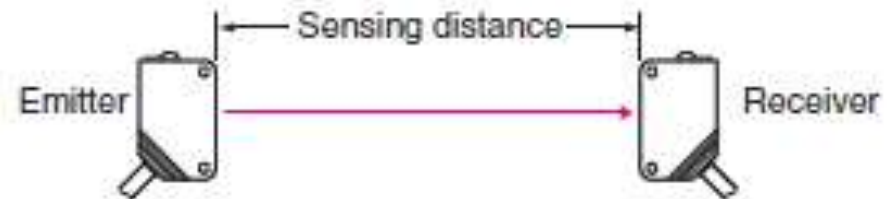
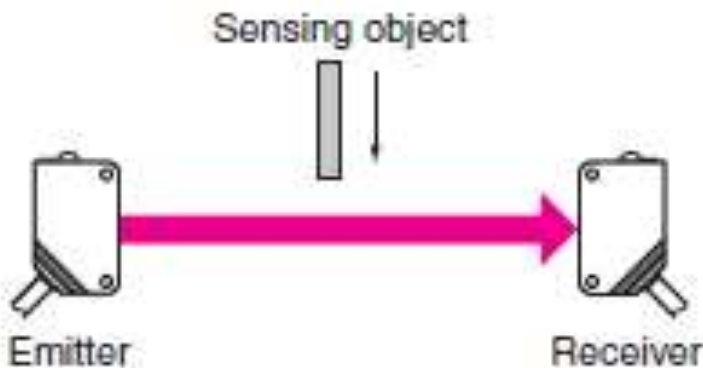

**Mane:** - Predajnik i prijemnik se moraju postaviti na odvojenim mjestima. - Moraju da se postavljaju zasebni kablovi za obje strane.

# Odbijajući (retrorefleksioni) davači

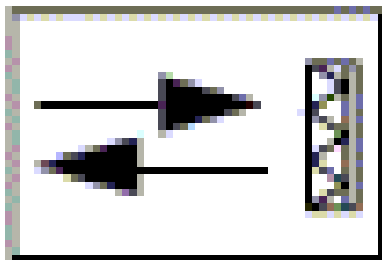

Simbol za odbijajući davač

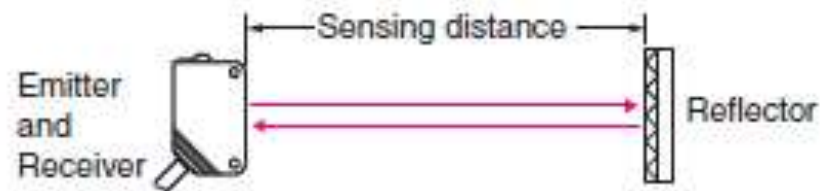
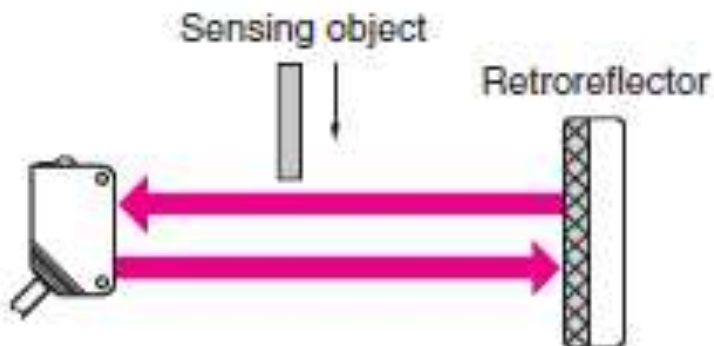
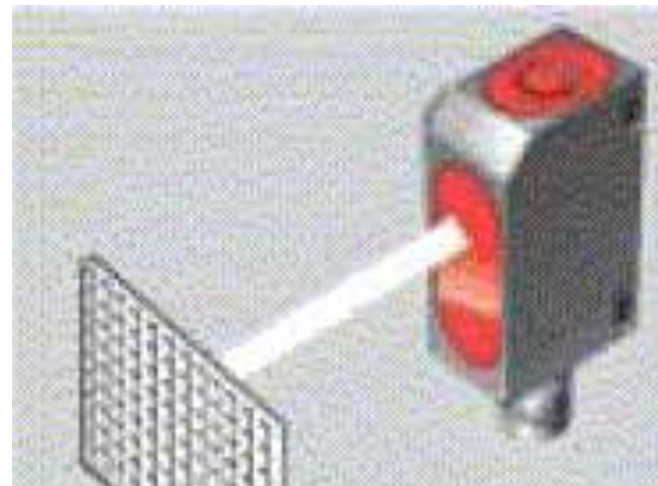

Predajnik i prijemnik su u istom kućištu, a sa druge strane je ogledalo koje odbija svjetlosni zrak nazad.

# Odbijajući (retrorefleksioni) davači

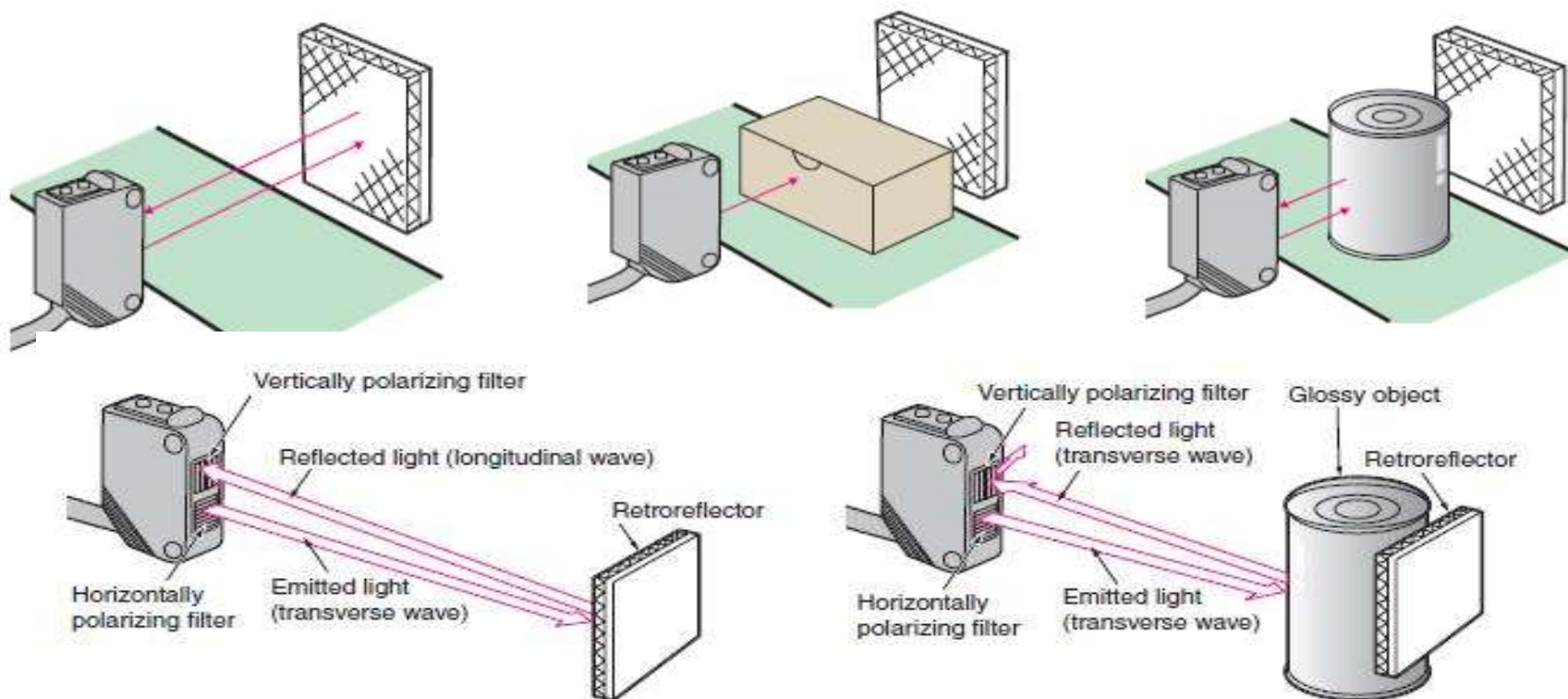

Predajnik emituje horizontalno polarizovanu svjetlost. Specijalno ogledalce vraća zrak sa zakrenutom (vertikalnom) polarizacijom kojeg prijemnik uspješno prima. Kada se zrak odbije od nekog drugog objekta, na prijemnik se vraća zrak sa horizontalnom polarizacijom koji neće biti primljen.

# Difuzioni optički davač

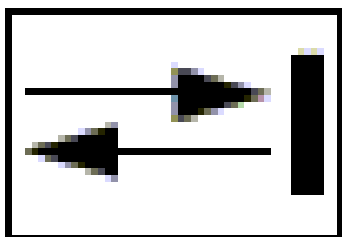

Simbol za  
difuzioni  
davač

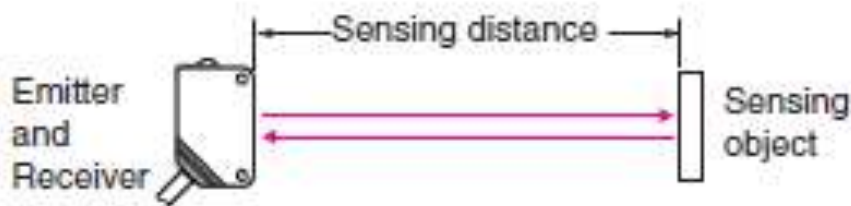
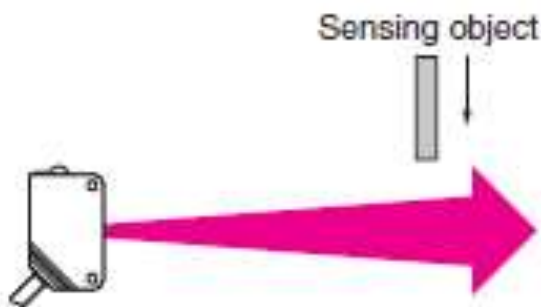
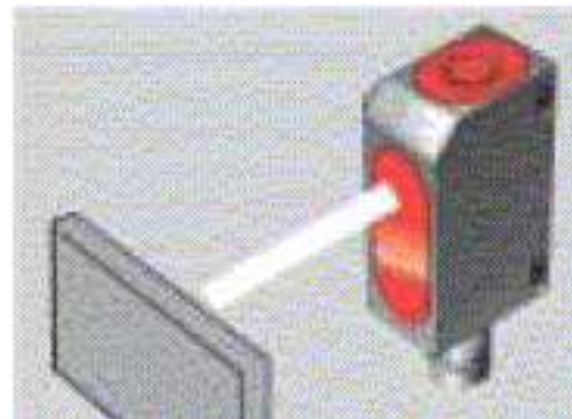

Sličan je odbijajućem davaču. Predajnik i prijemnik su u istoj kutiji. Međutim, ovdje se ne koristi ogledalce. Svjetlost se rasipa od objekta i detektuje u prijemu.

# Senzor za procjenu rastojanja objekta

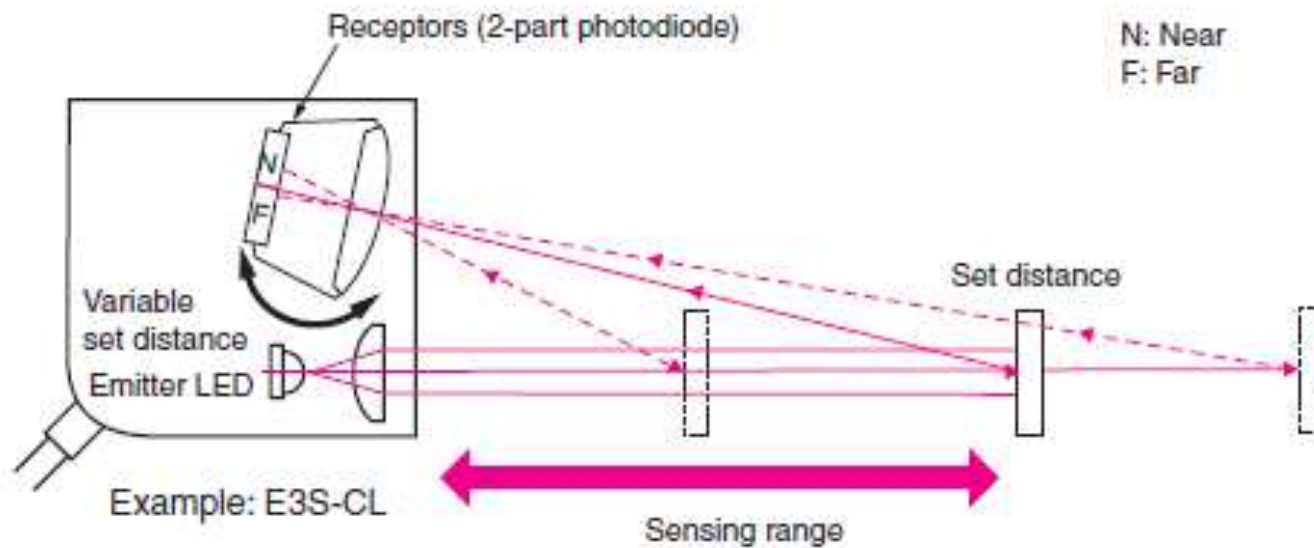

Prijemnik senzora je dvodjelna fotodioda ili pozicioni detektor.

Reflektovana svjetlost je koncentrisana na dijelu prijemnika.

Detekcija je zasnovana na principu mjerenja ugla. Pozicija na kojoj će reflektovana svjetlost biti koncentrisana zavisi od rastojanja objekta.

# Senzor za procjenu rastojanja objekta

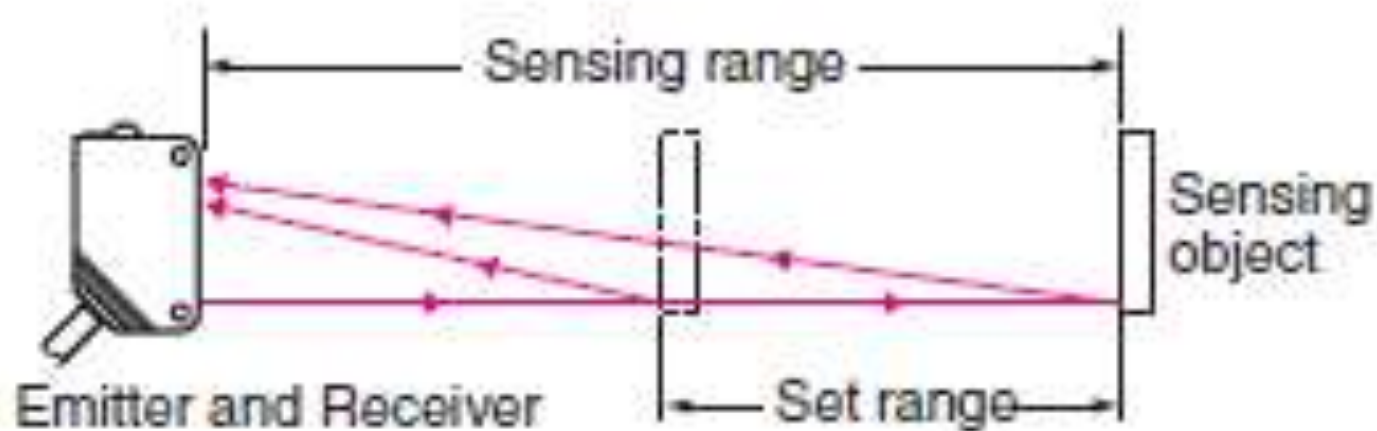

Kod ove vrste senzora može se podesiti opseg rastojanja u kome će objekat biti detektovan.



# Senzor ograničene refleksije

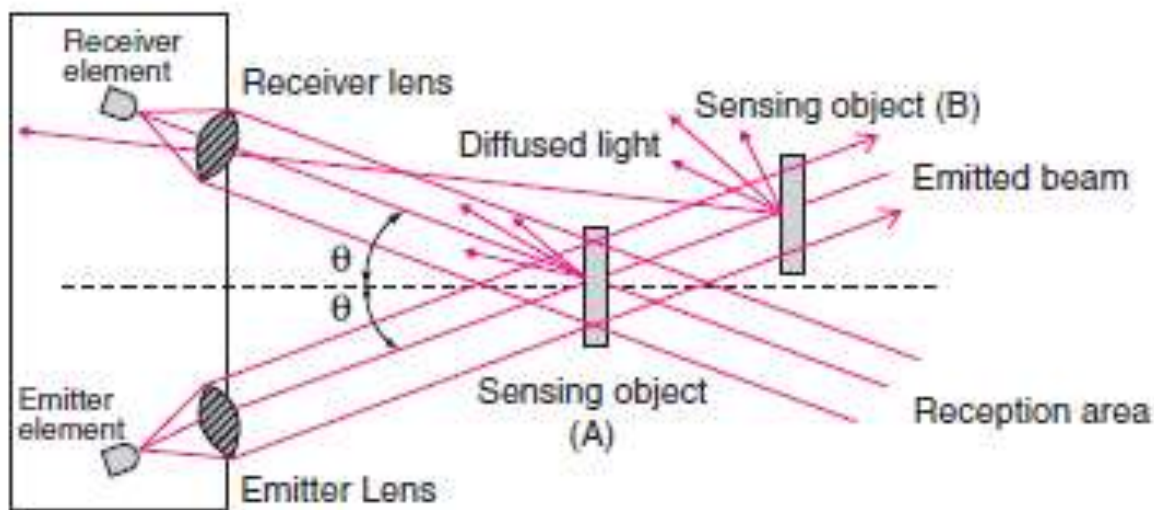

Slično kao difuzioni senzor, detektuje svjetlost reflektovanu od objekta. Međutim, uglovima je podešeno da detektuje objekte samo na jednom određenom rastojanju, ni bliže, ni dalje.

# Senzor ograničene refleksije

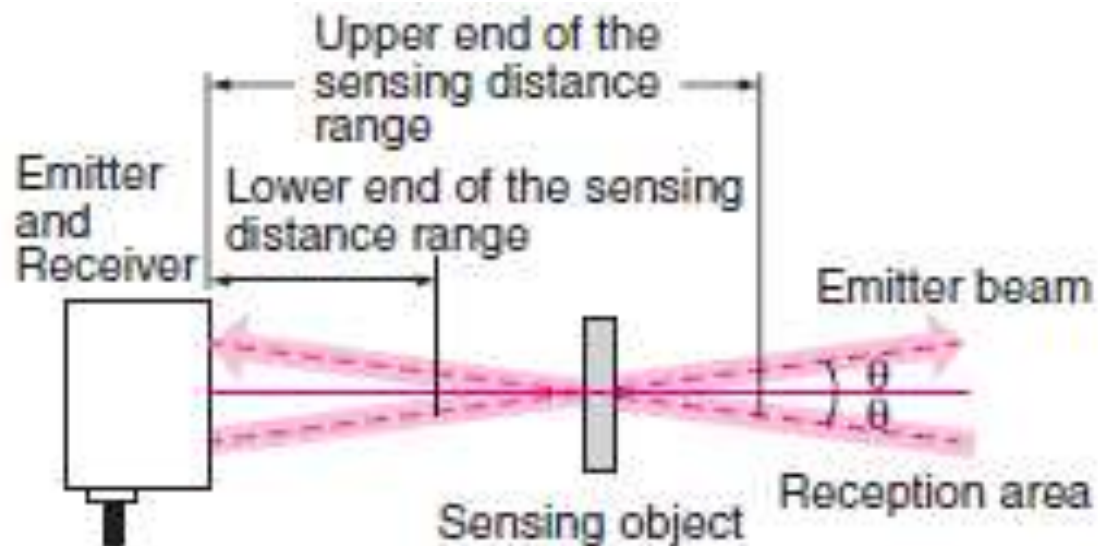

# Davači sa optičkim vlaknima

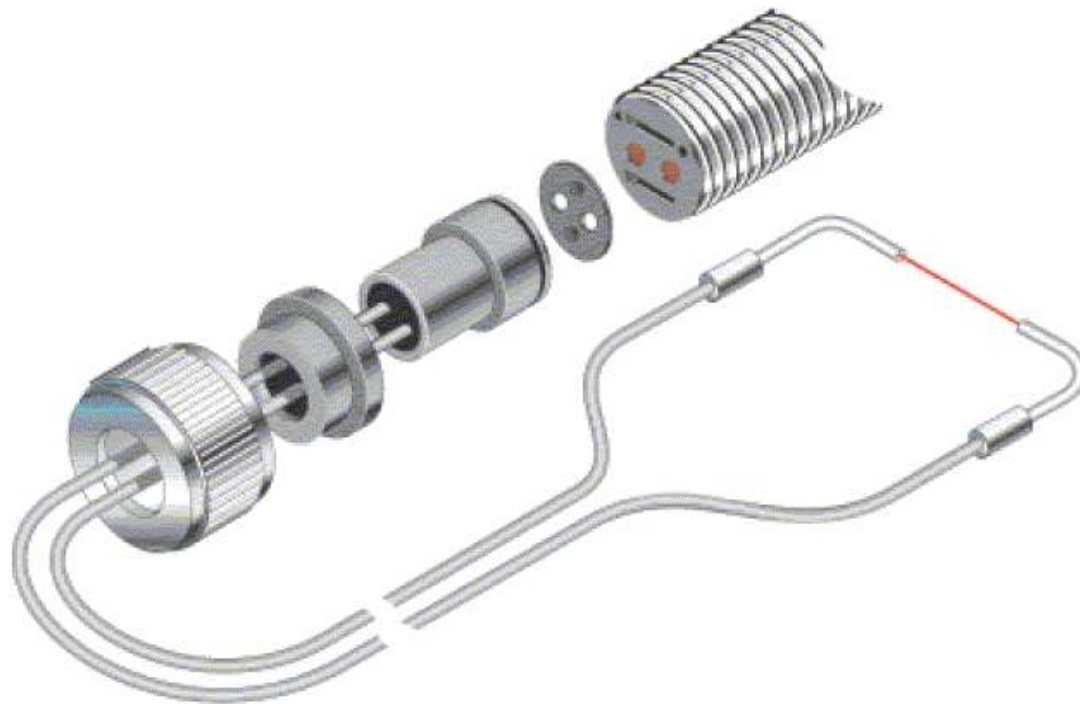

Zahvaljujući optičkim vlaknima svjetlosna linija može da se postavi precizno i na teško dostupnim mjestima.

# Laserski davač rastojanja

Predajnik emituje uski laserski zrak. Prijemnik (u vidu linijske kamere) vidi osvjetljenu tačku na objektu pod određenim uglom. Na osnovu tog ugla određuje se daljina objekta.



# Izgled gotovih senzora



Reflex edge sensor



High performance  
line/edge sensor



Low cost line/edge sensor

# Optički skener otiska prsta

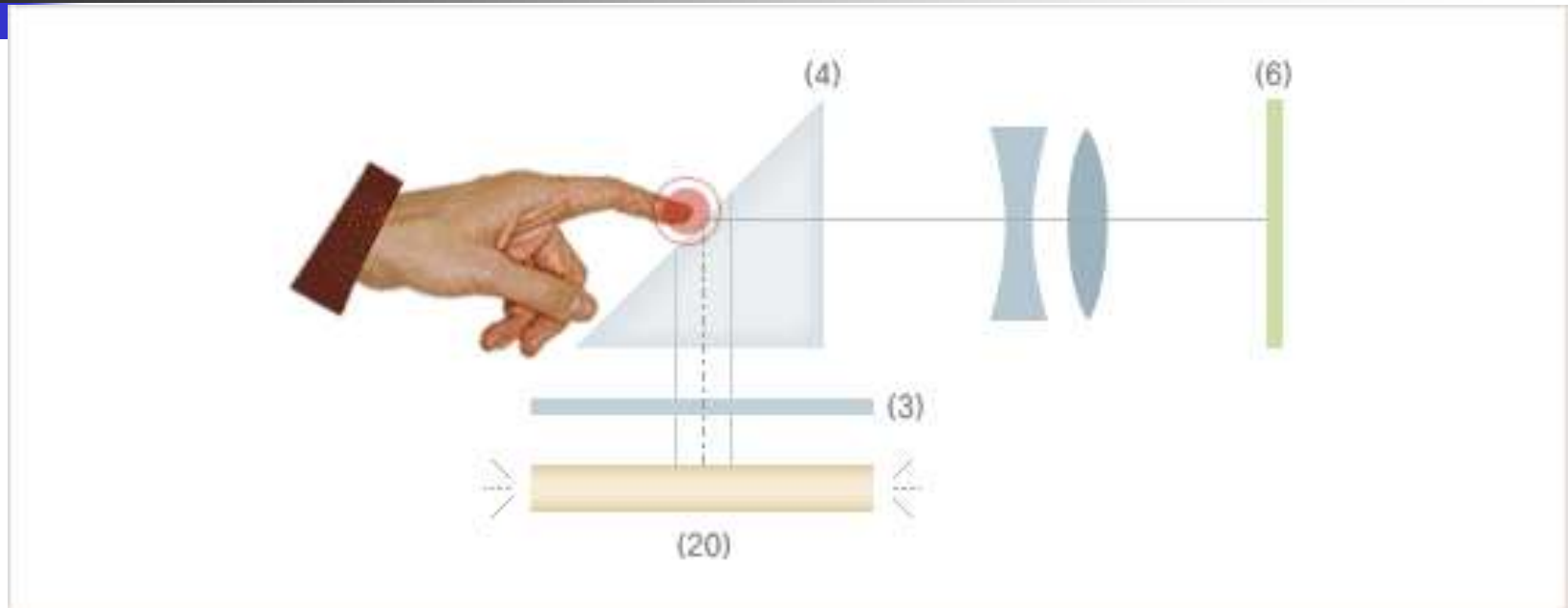

Sistem sočiva kod optičkih fingerprint senzora

Prst se prisloni na pločicu, osvijetli sa LED izvorom svjetlosti i kroz prizmu i sistem sočiva slika se projektuje na kameru.

# Primjene skenera otiska prsta



Koristi se za ovlašćeni pristup:

- prostorijama,
- podacima,
- računaru ili
- nekom drugom sadržaju (na primjer tašni).

# Optička viljuška je prolazni senzor

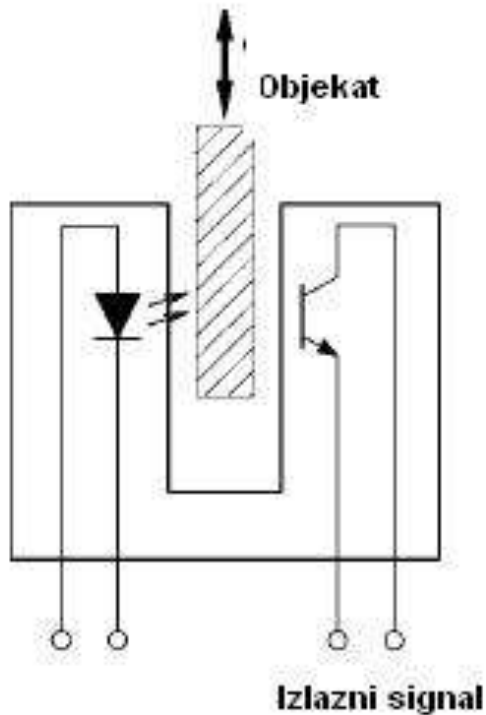

Princip rada optičke viljuške i njezin izgled

Dimenzije viljuške su oko 1cm.



# Blizinski difuzioni davači

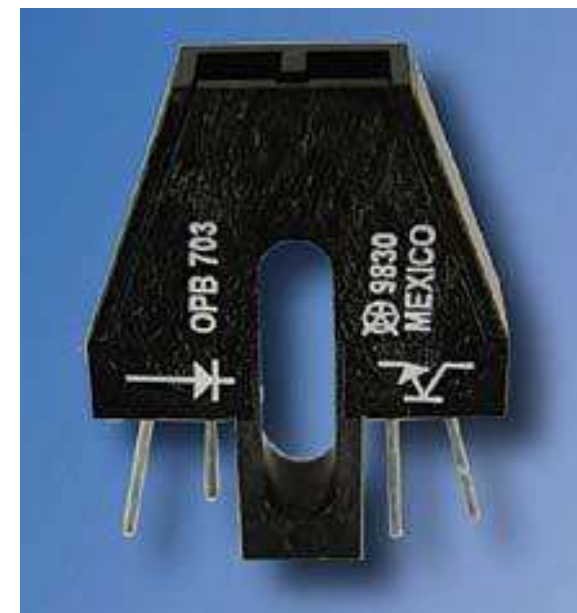
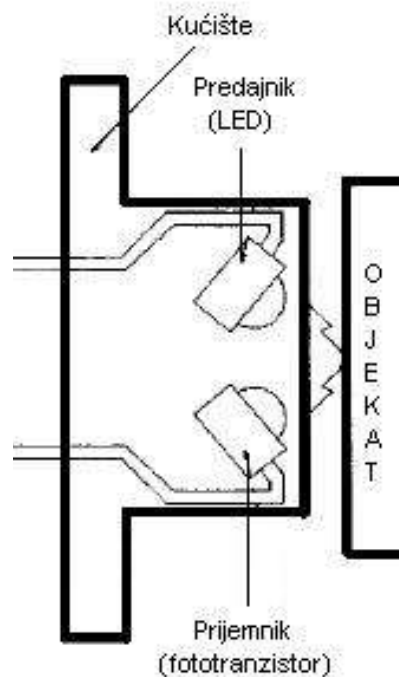
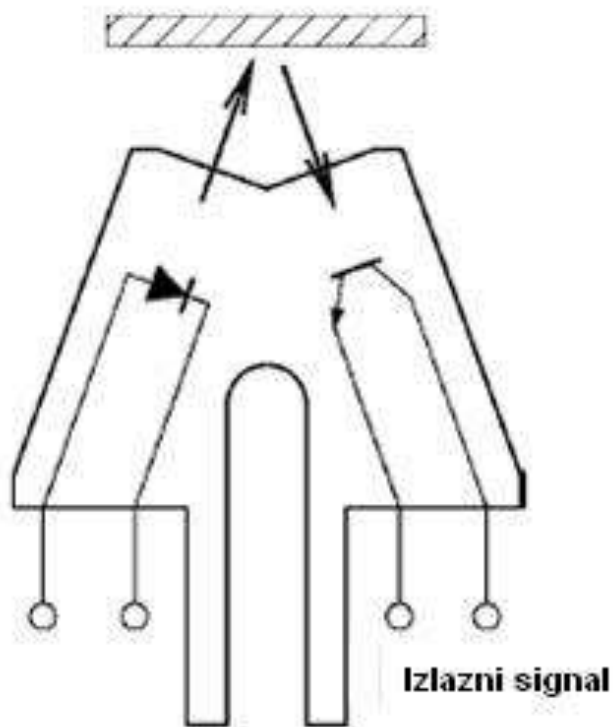

Princip rada blizinskog difuzionog davača i njegov izgled

Dimenzije davača su oko 1cm.

# Veličina blizinskog senzora

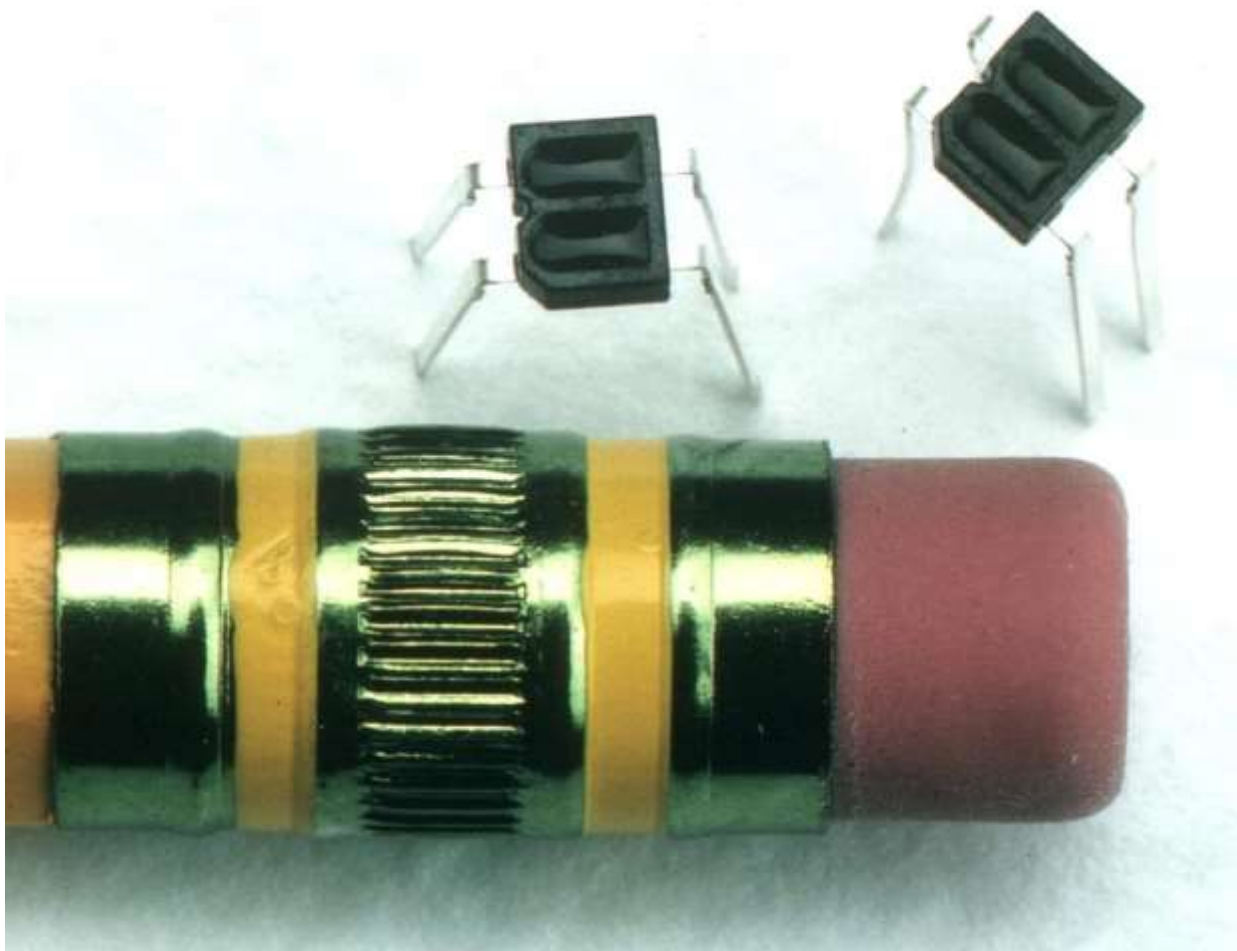

# Optički miš

[http://en.wikipedia.org/wiki/Optical\\_mouse#Optical\\_mice](http://en.wikipedia.org/wiki/Optical_mouse#Optical_mice)

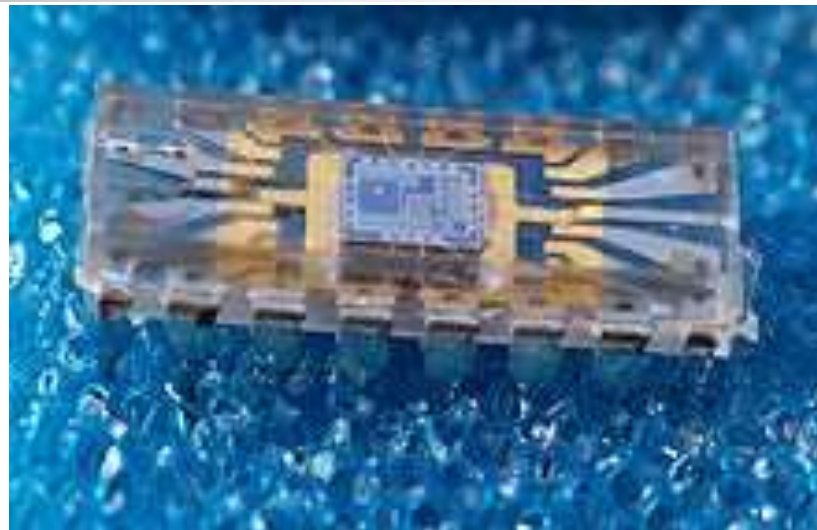

optički čip

Optički miš se sastoji od:

- LED (ili lasera) za osvjetljavanje podloge,
- minijaturne kamere sa optičkim čipom (optical 3000dpi – laser 6000dpi-15000+dpi),
- čipa za obradu slike i komunikacije sa PC-om.

Optički miš se može pretvoriti u skener. Više detalja ima na

<http://spritesmods.com/?art=mouseeye>

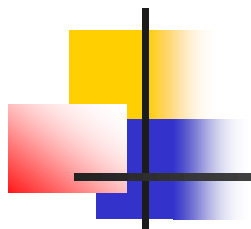

# Primjena optičkih davača

# Detektovanje pokretne neprozirne zastavice

## 1. Sensing of moving sheet metal

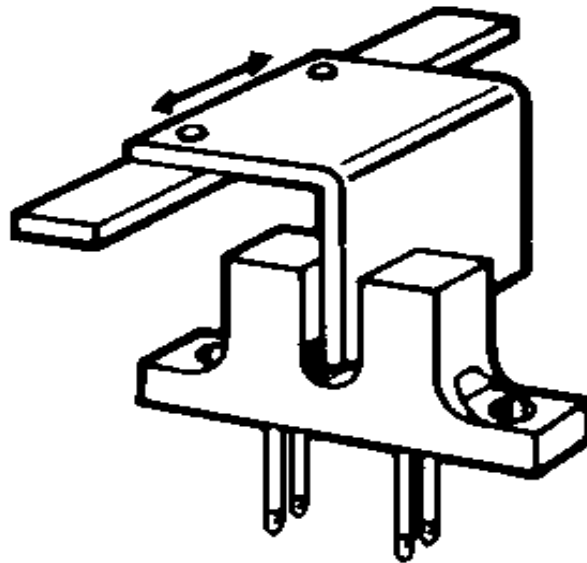

Obično služi kao detektor krajnjeg položaja mehanizma (u štampačima, ploterima, i raznim drugim uređajima).

# Detektovanje kovanog novca i metalnih komada

## 2. Sensing of coin and metal

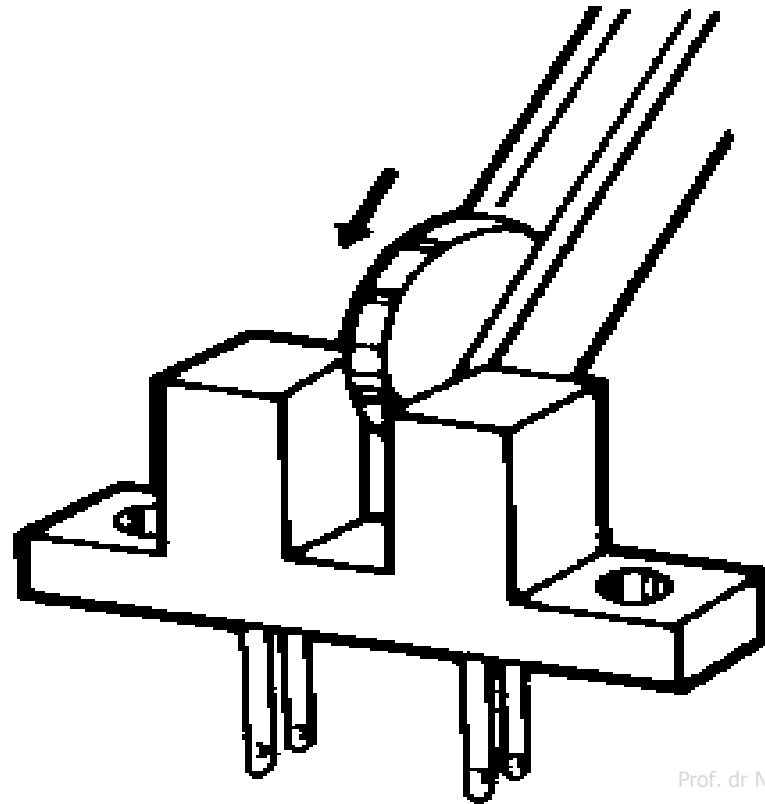

# Detektovanje zubaca kod prenosnih mehanizama

## 3. Sensing of gear tooth

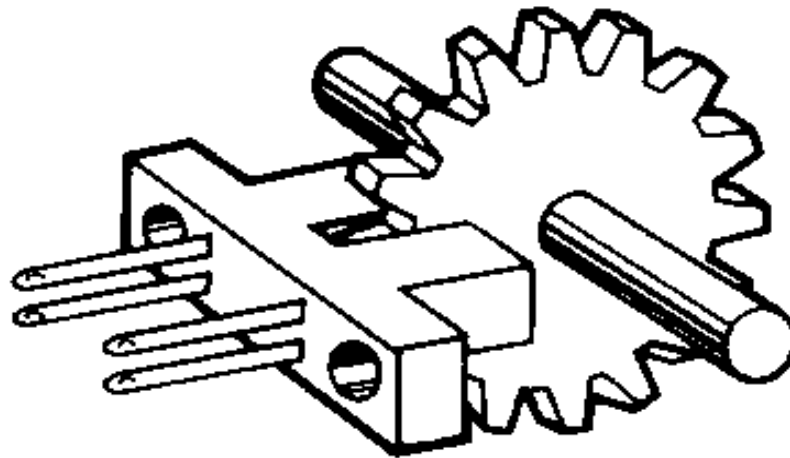

Okretanjem zupčanika dobijaju se impulsi na fotoprijemniku. Broj impulsa u sekundi je mjera brzine obrtanja zupčanika.

# Detektovanje položaja filma

## 5. Sensing of film position

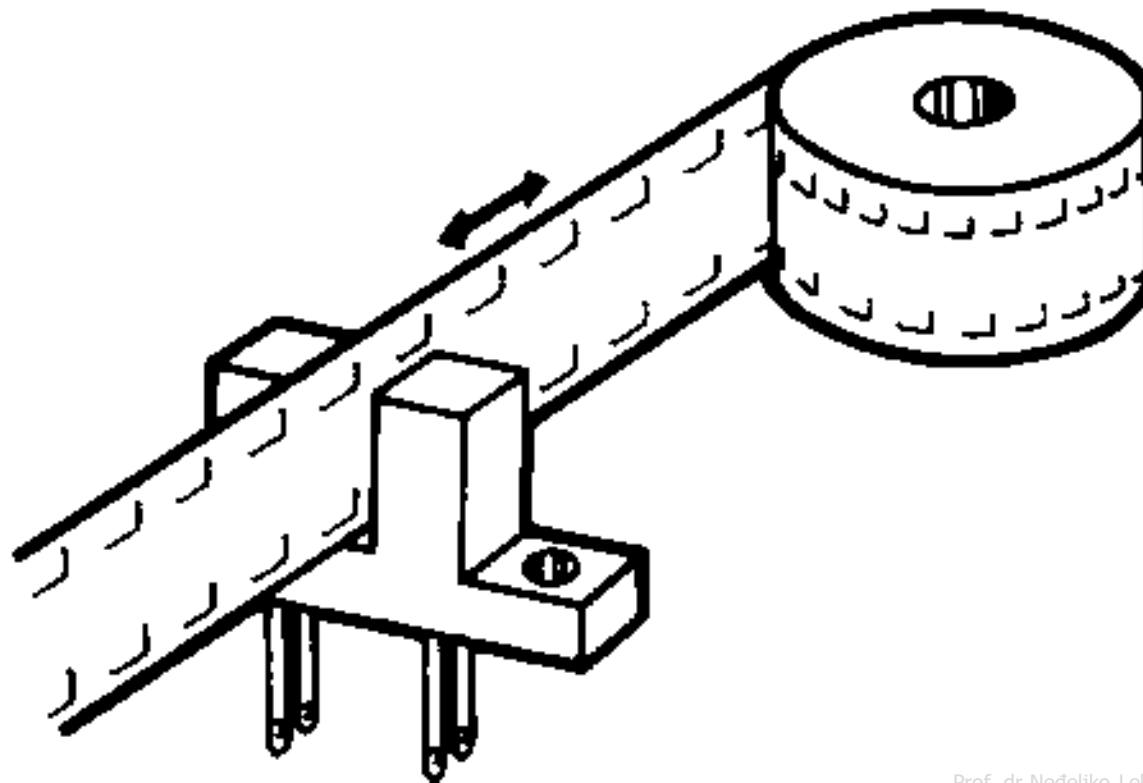



# Detektovanje broja okretaja

## 6. Sensing of the number of revolutions

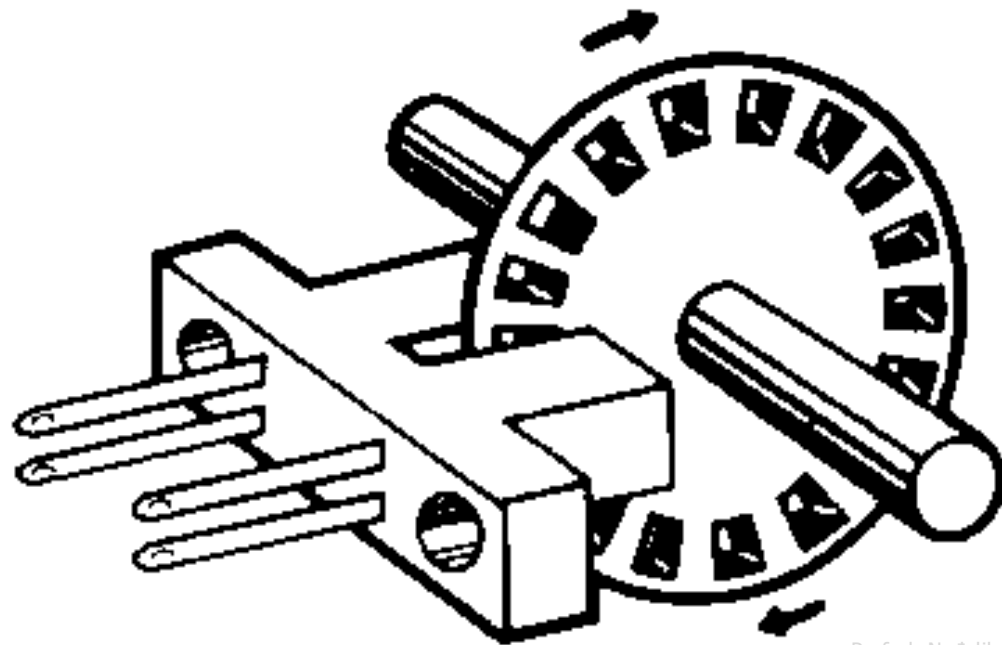

# Detektovanje sjajne zastavice

## 1. Sensing of glossy sheet metal

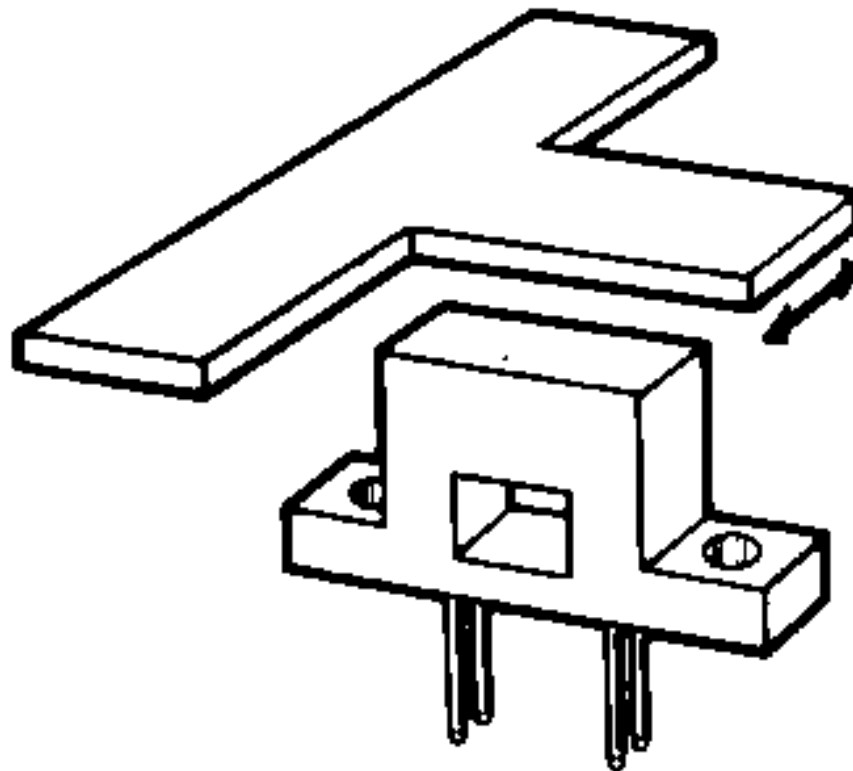

# Detektovanje kraja ili početka trake

## 2. Sensing of the end or beginning of tape

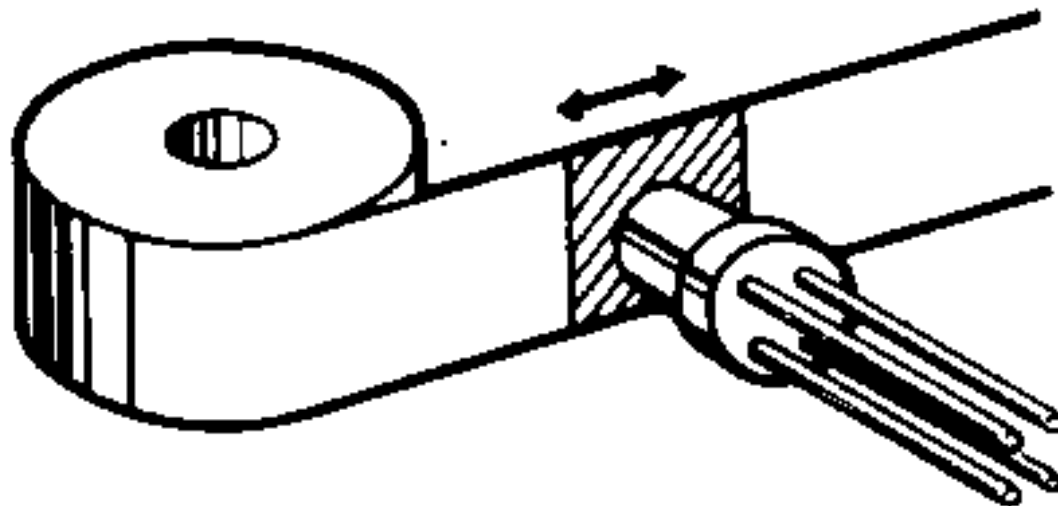

# Detektovanje sjajnih zubaca

## 3. Sensing of glossy gear tooth

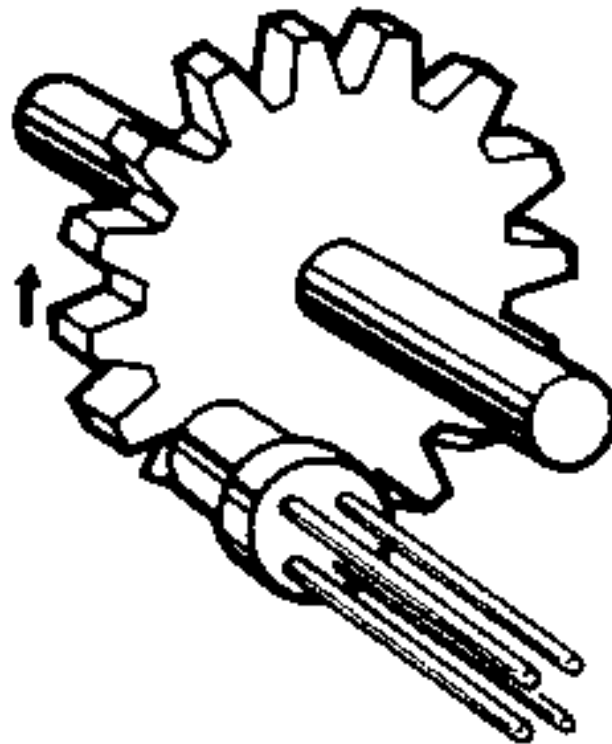

# Kontrola visine karmina prije postavljanja poklopca

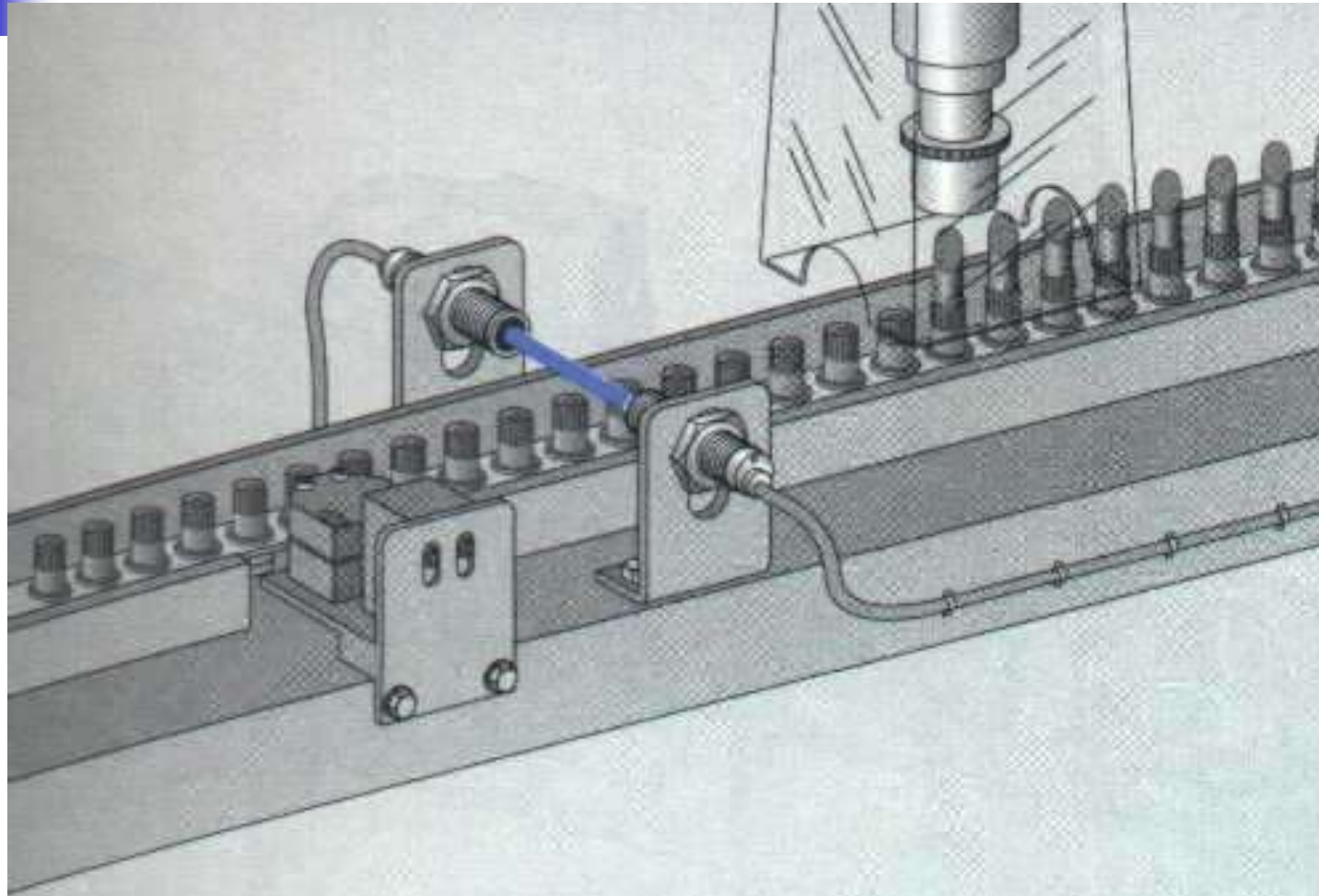

# Kontrola prolaska paleta sa flaširanom vodom

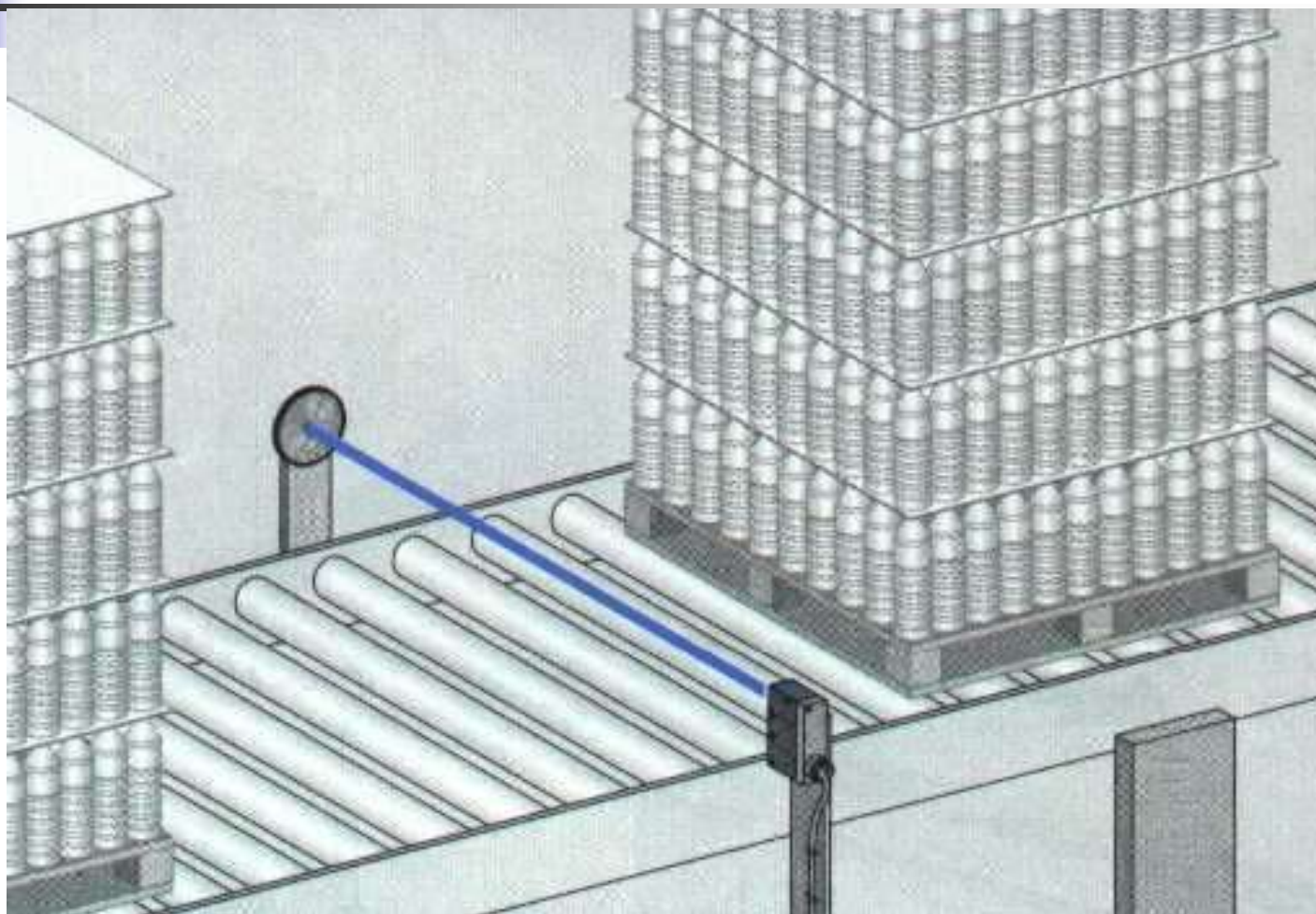

# Kontrola prolaska konzervi (sa hranom za mačke)

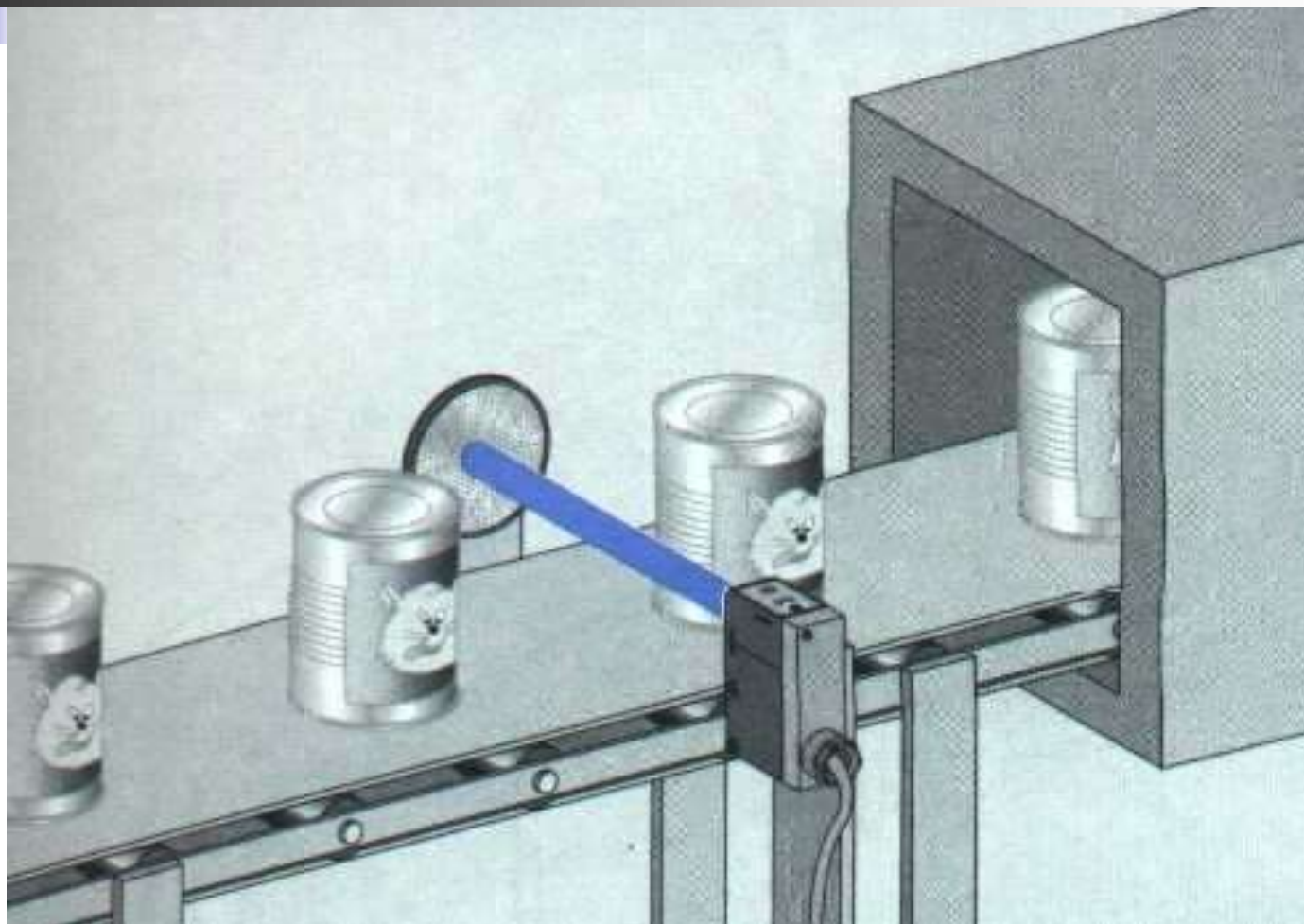

# Provjera prisustva plastičnog čepa

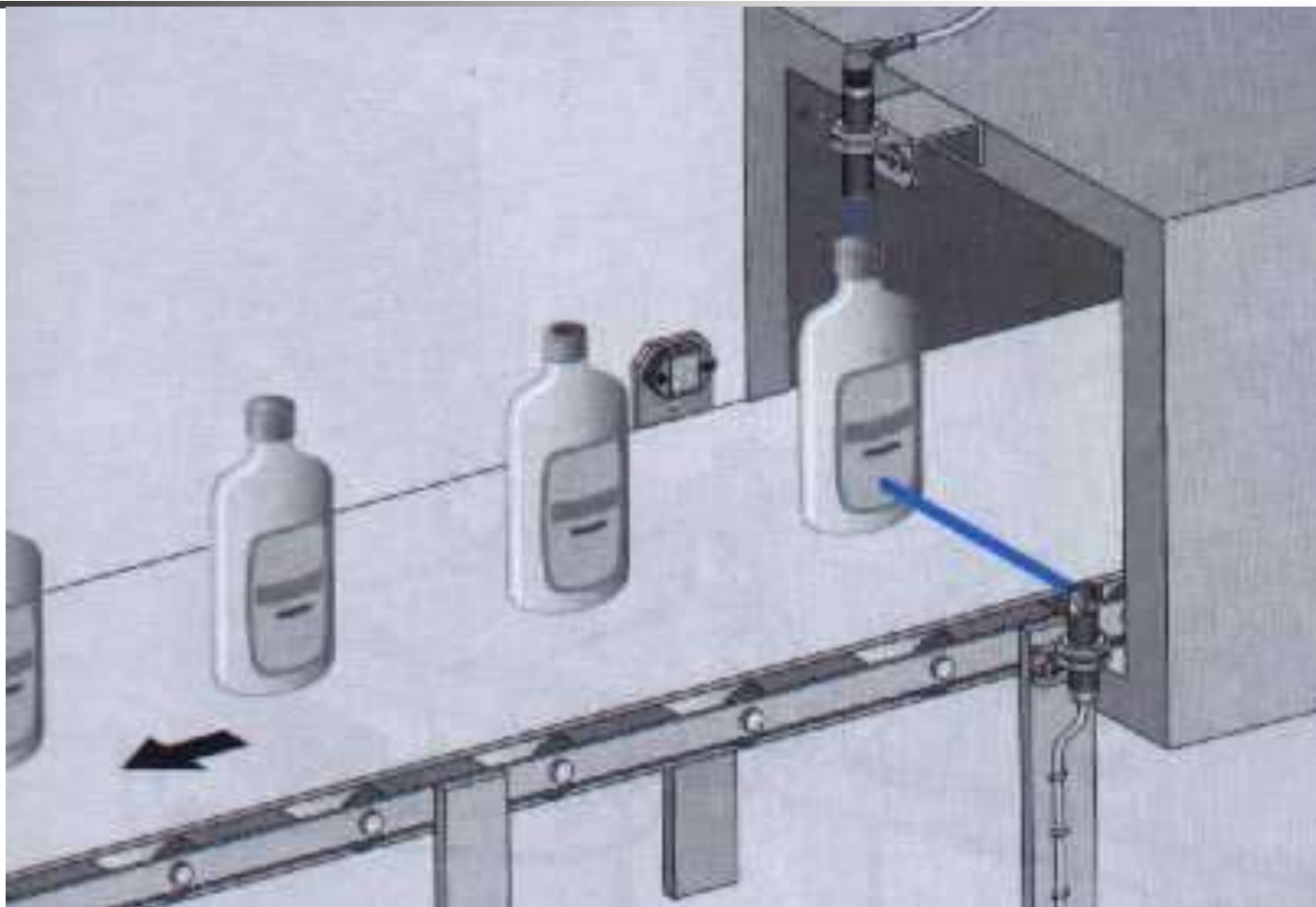



# Kontrola tableta u bočicama

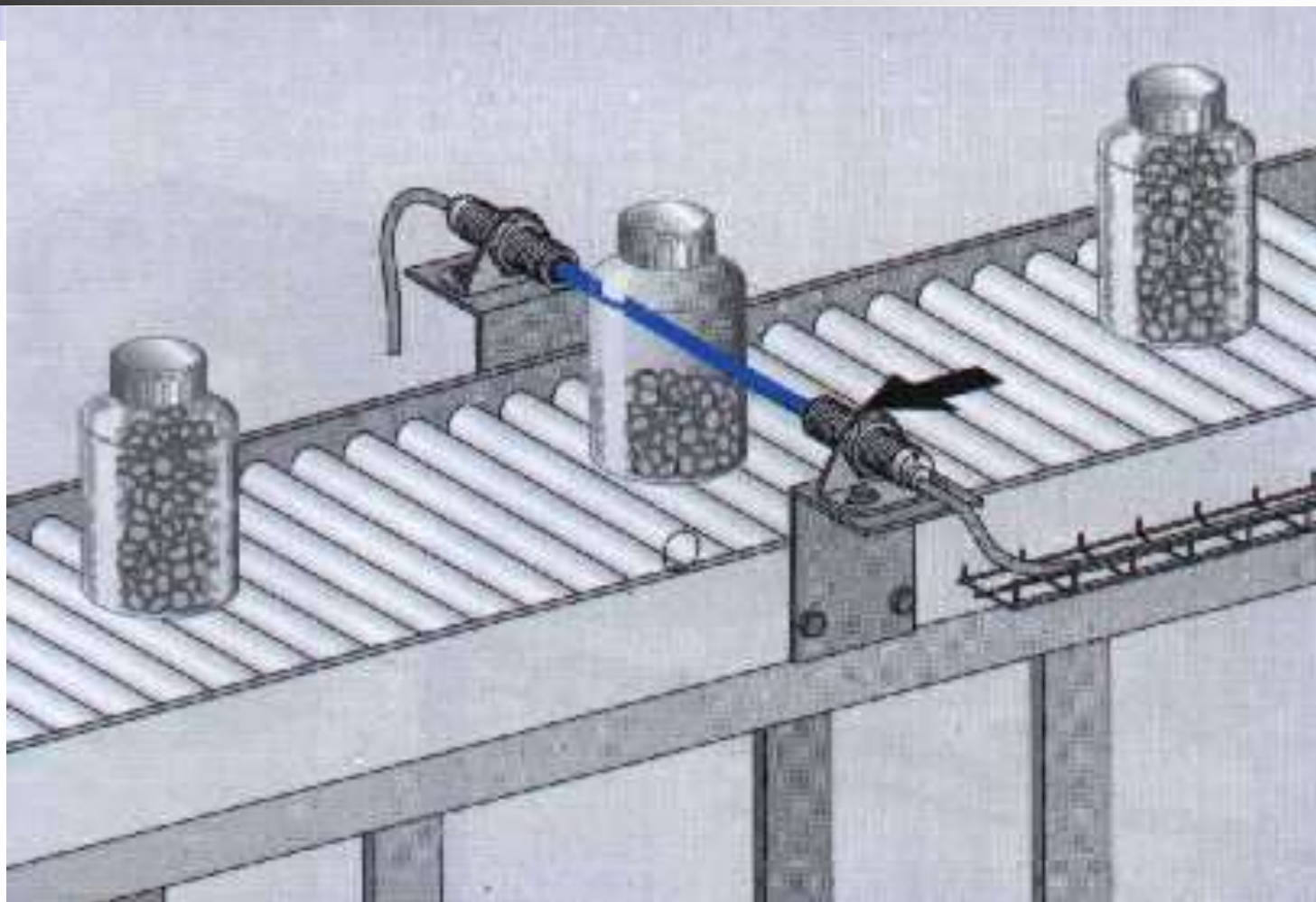

# Kontrola naljepnica na bočicama

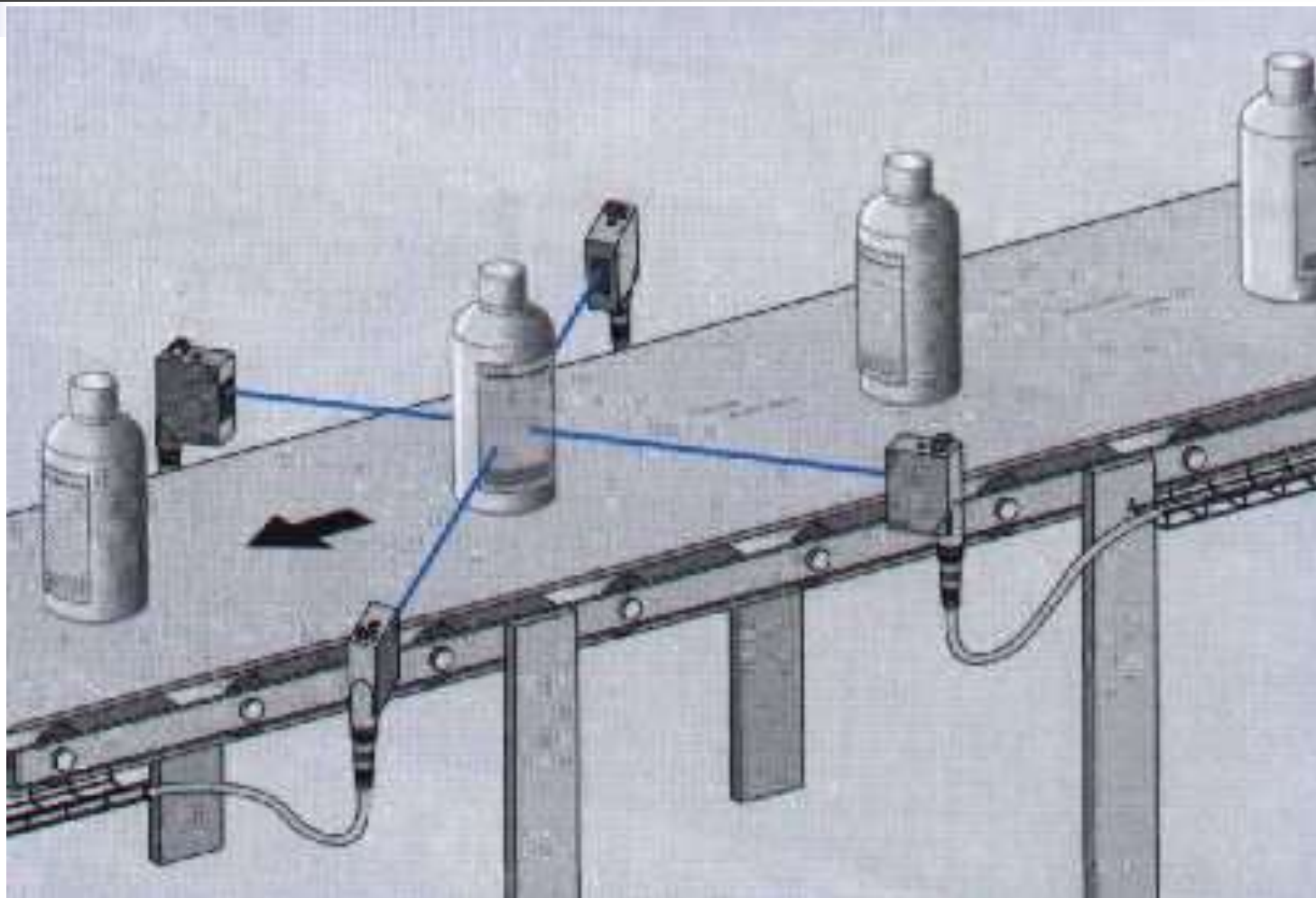

# Brojanje televizora

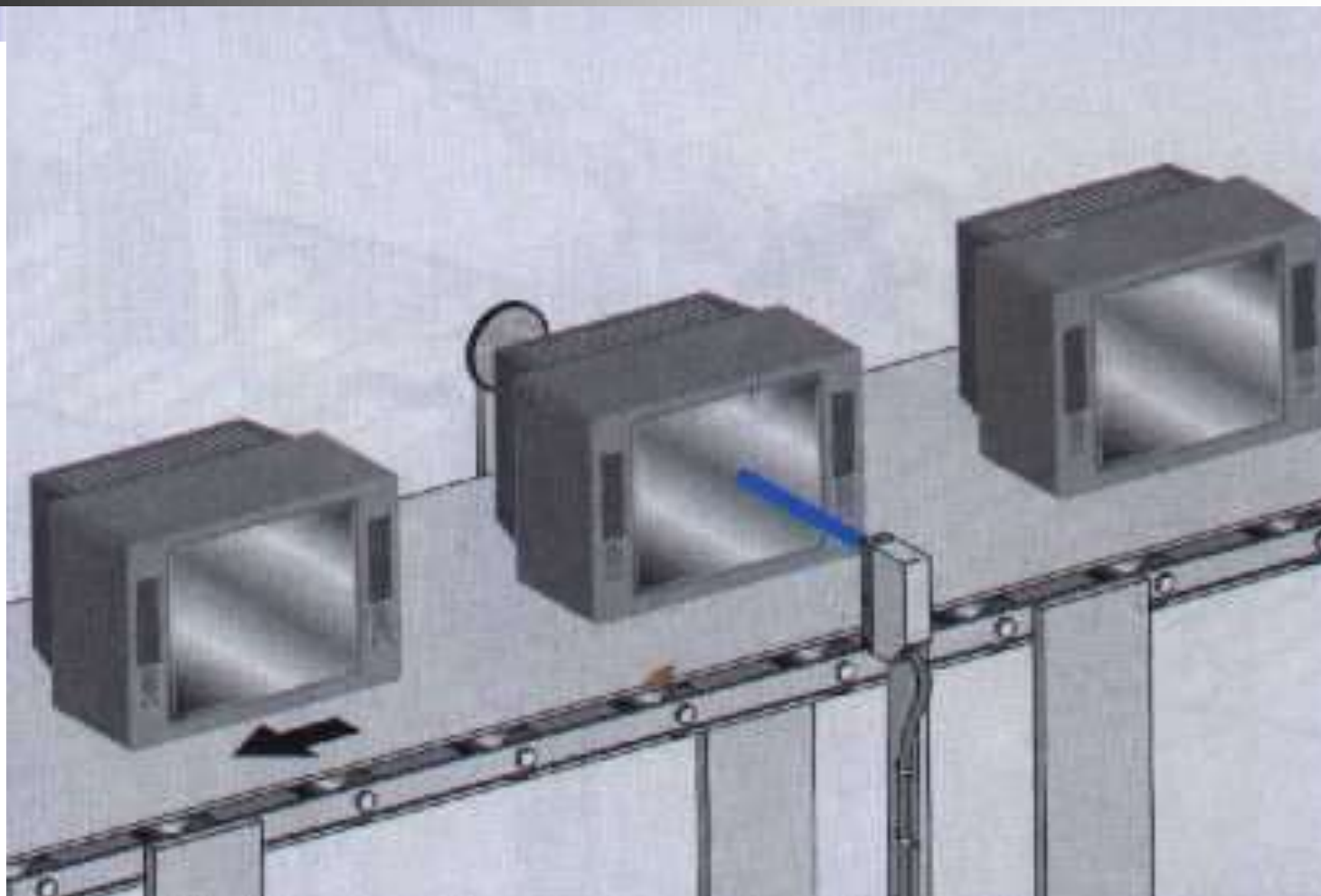

# Brojanje tableta

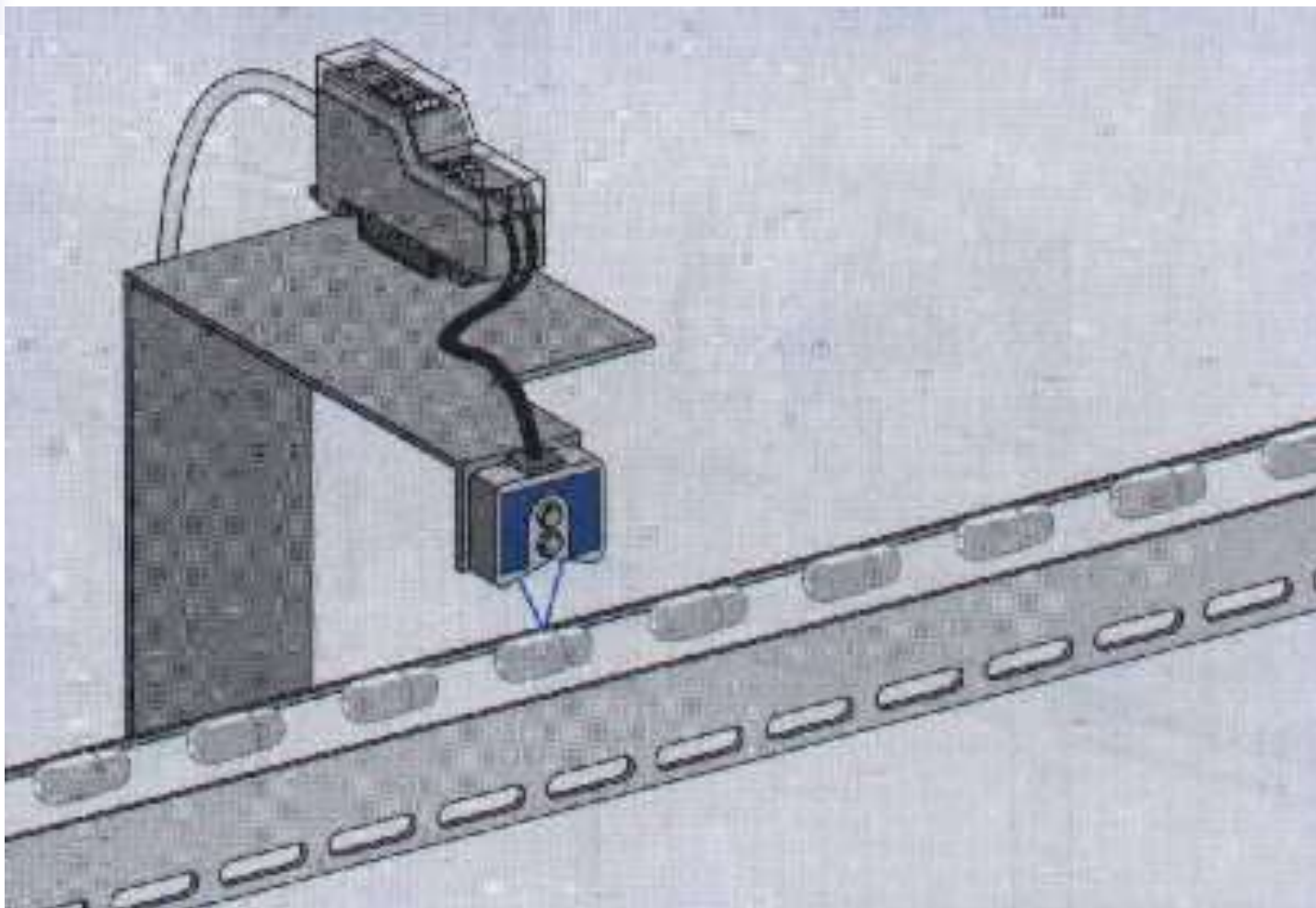

# Sinhronizacija rezanja na zadatu dužinu

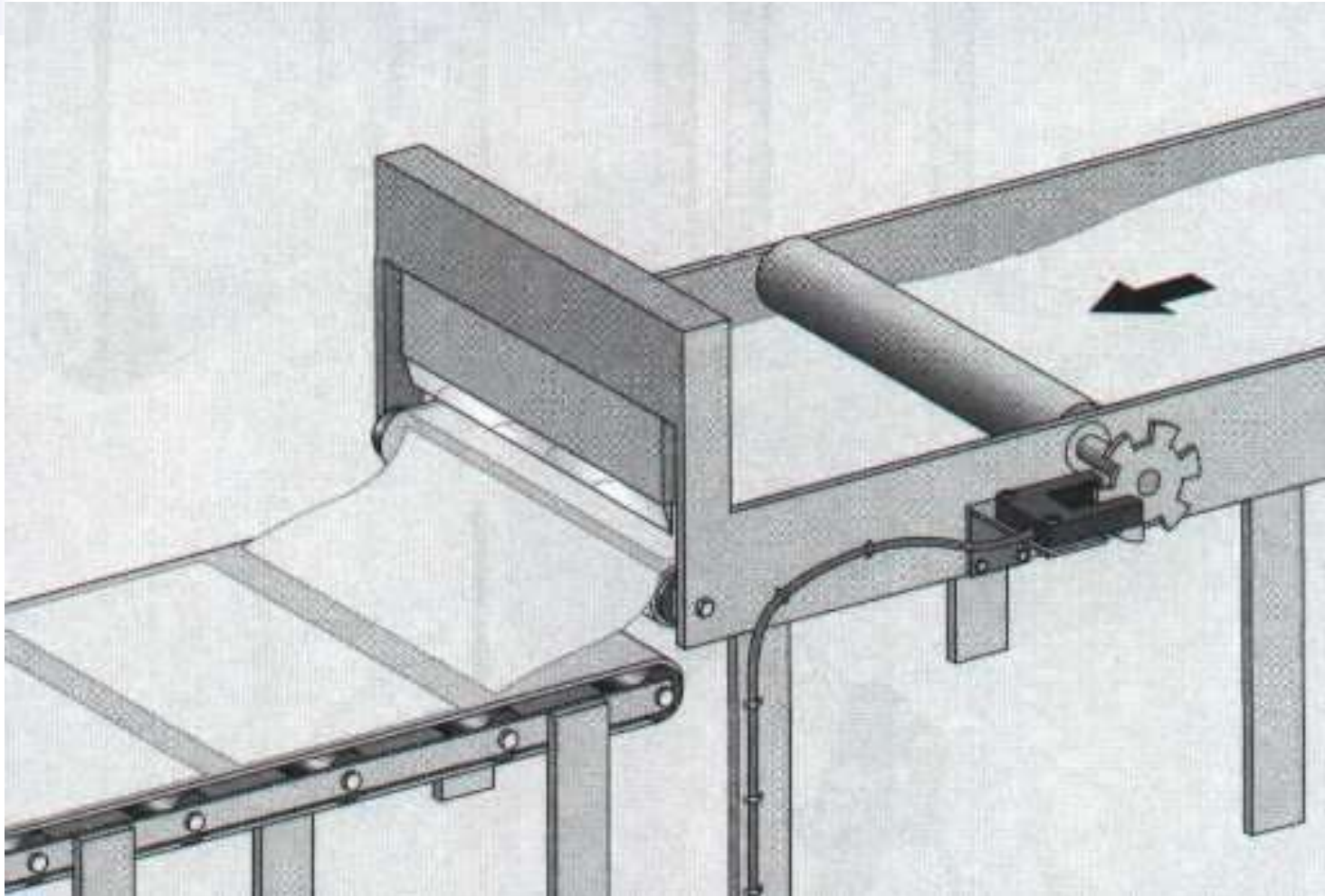

# Otkrivanje praznog pakovanja

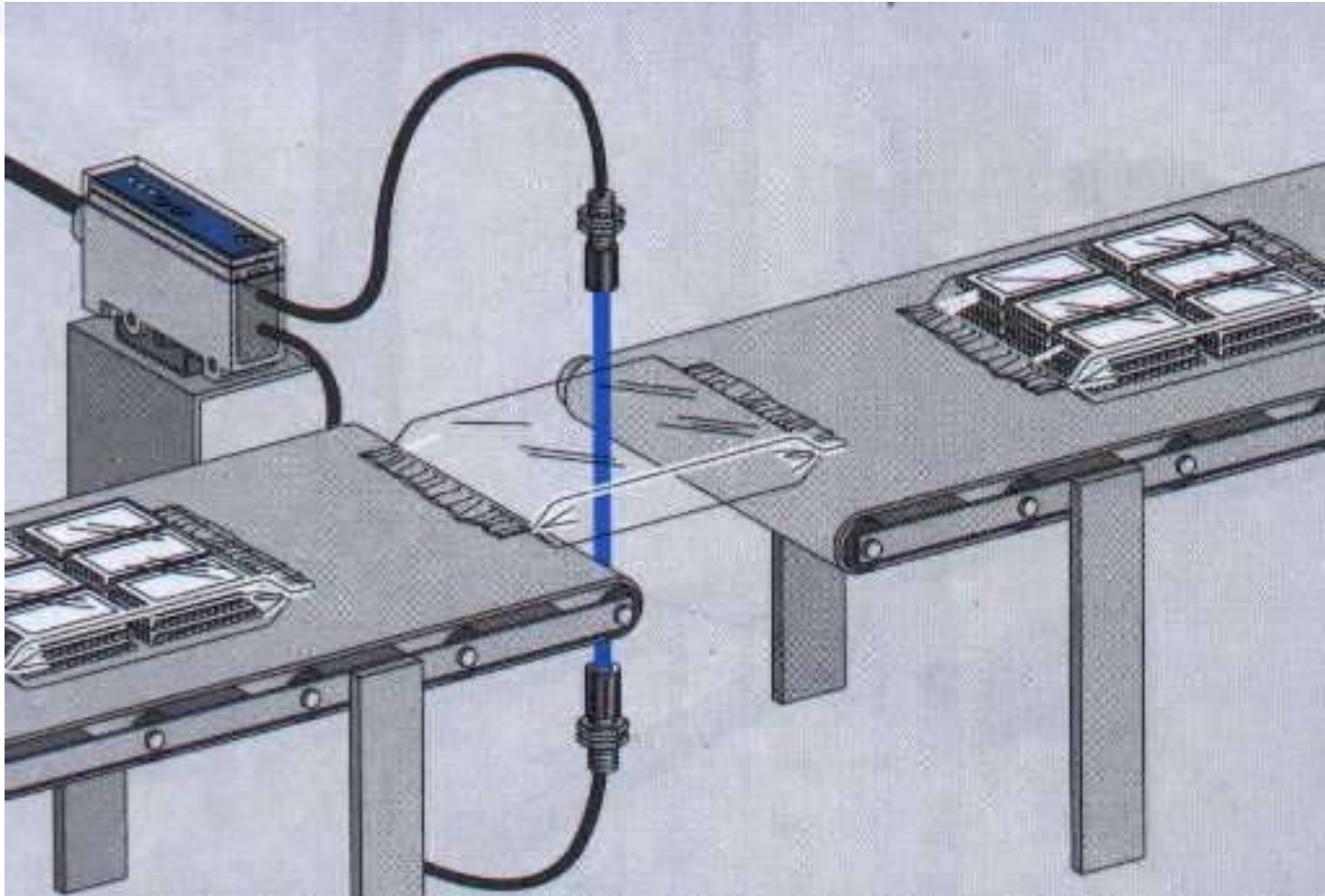

# Otkrivanje neispravnog položaja etikete

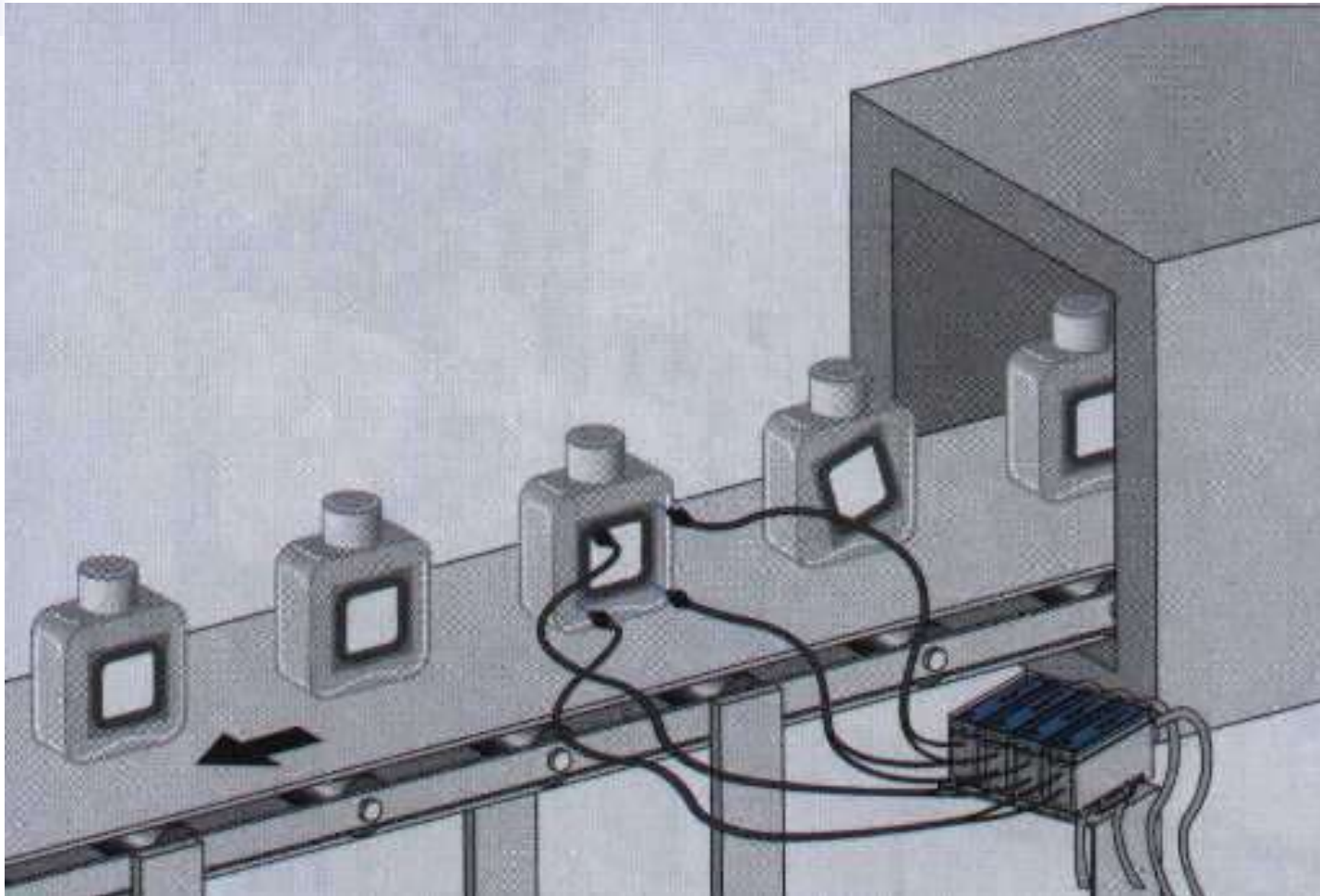

# Očitavanje referentne oznake radi rezanja na mjeru

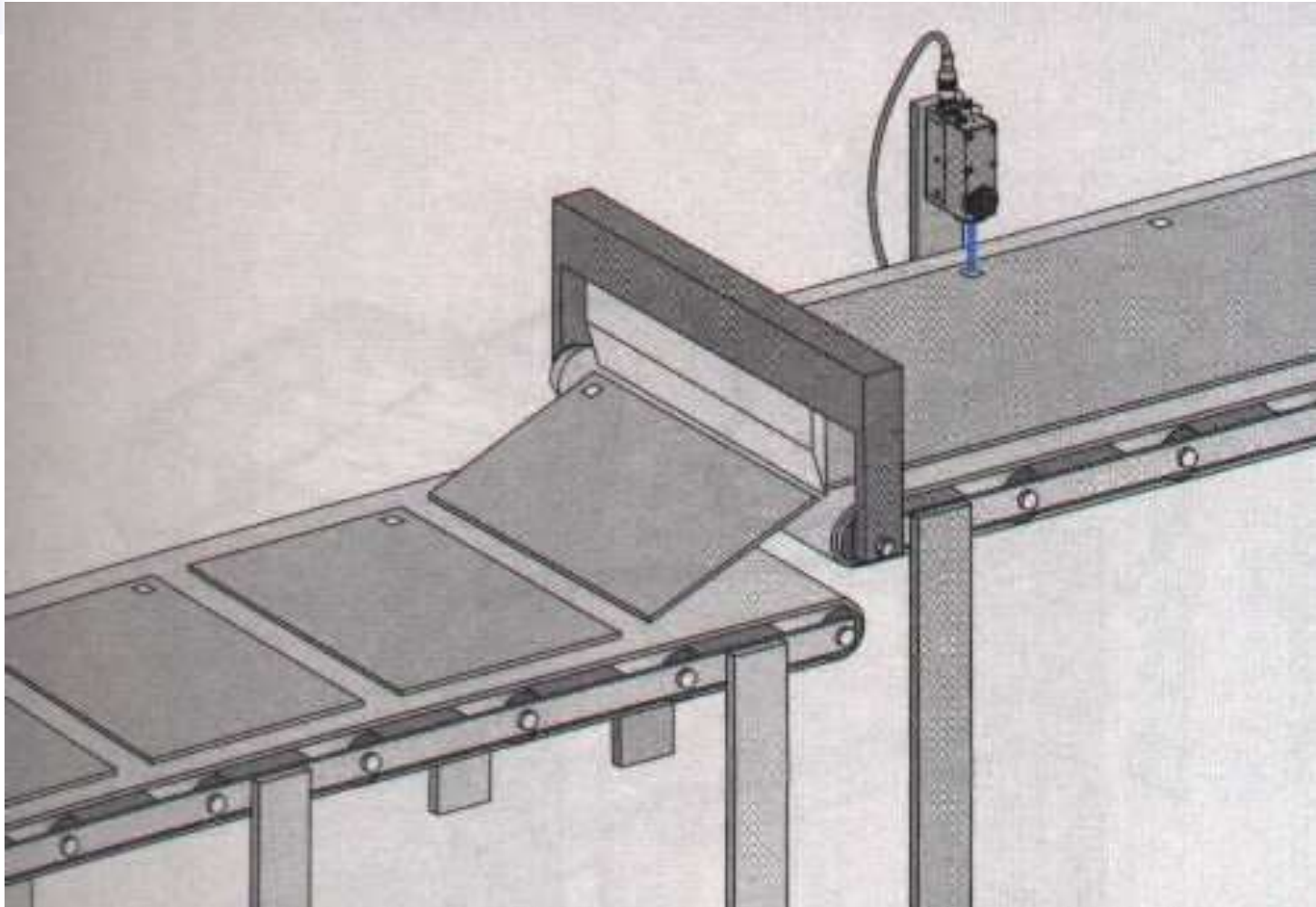



# Detekcija kraja rolne

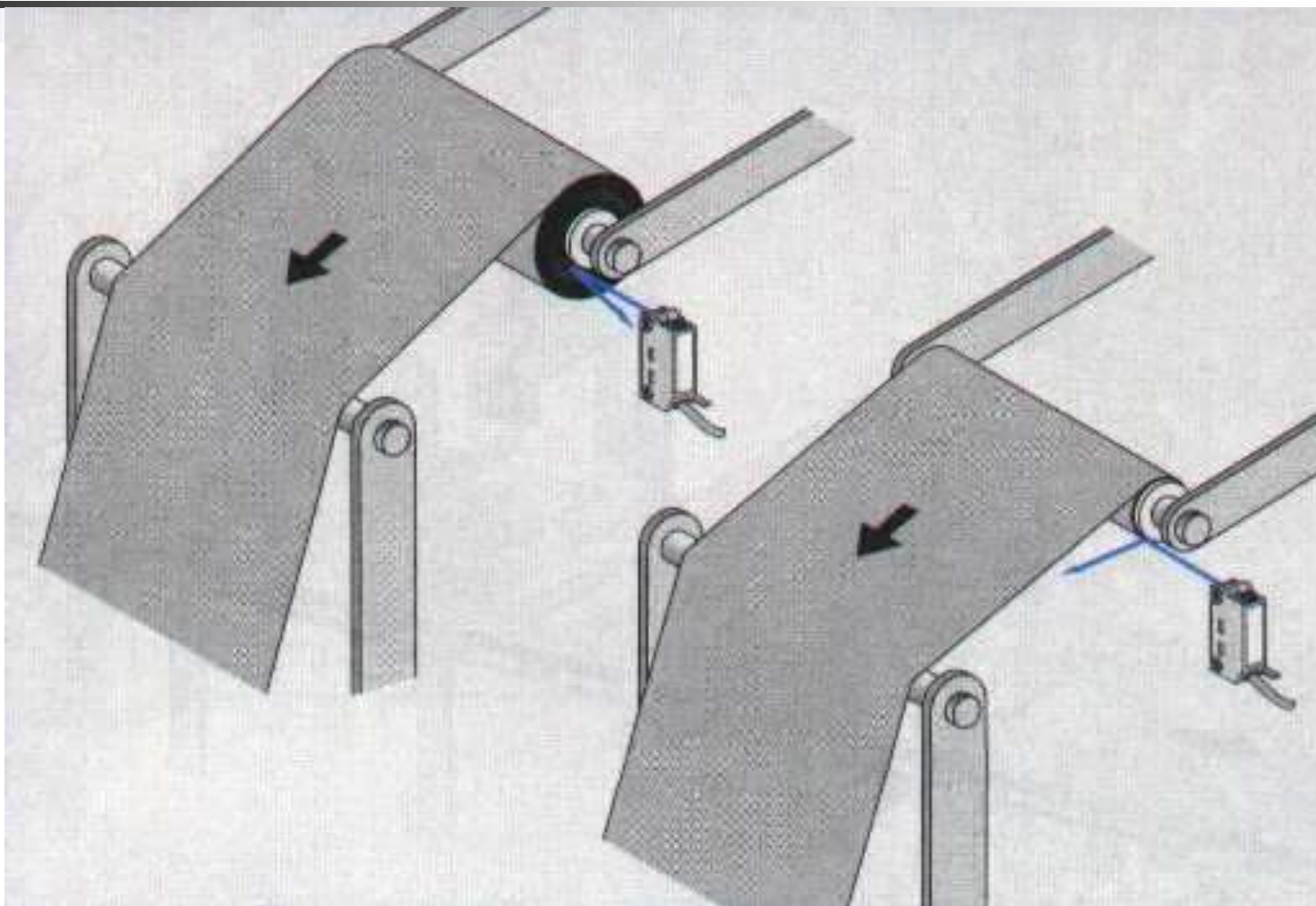

# Kontrola: "Ima li ljepila?"

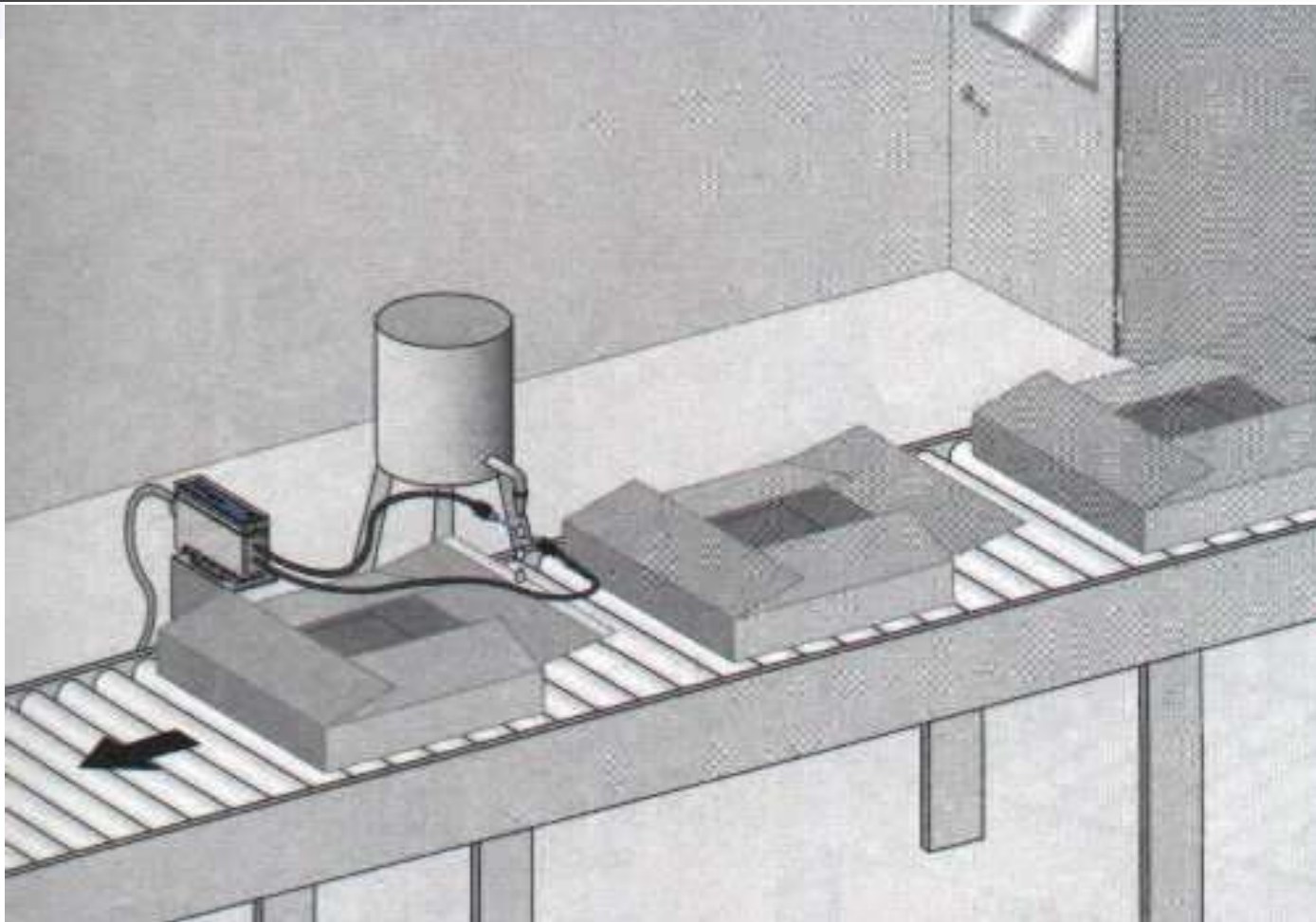

# Detekcija petlje (rezerve materijala)

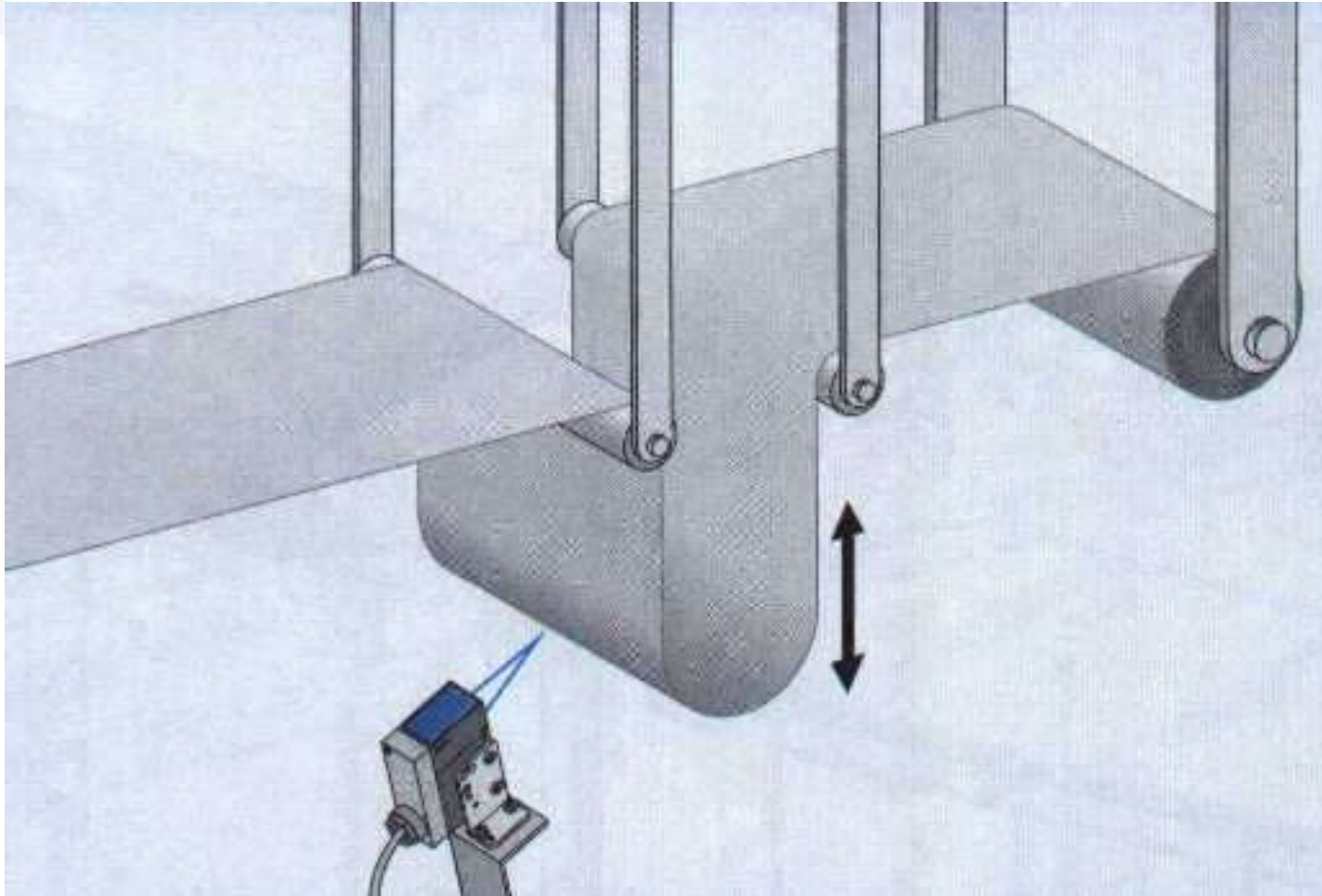

# Kontrola prolaska i brojanje kutija

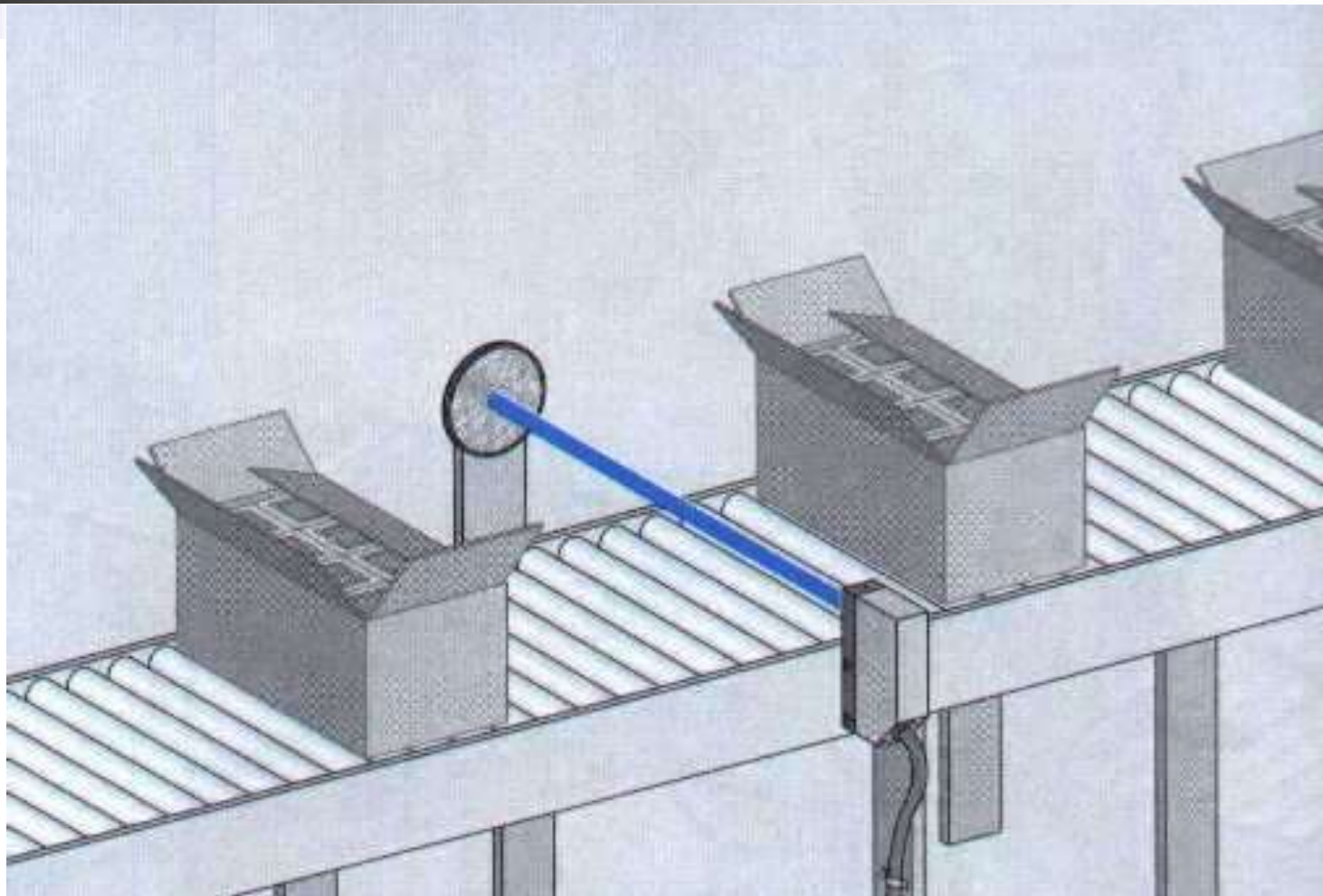

# Detekcija nailaska osobe

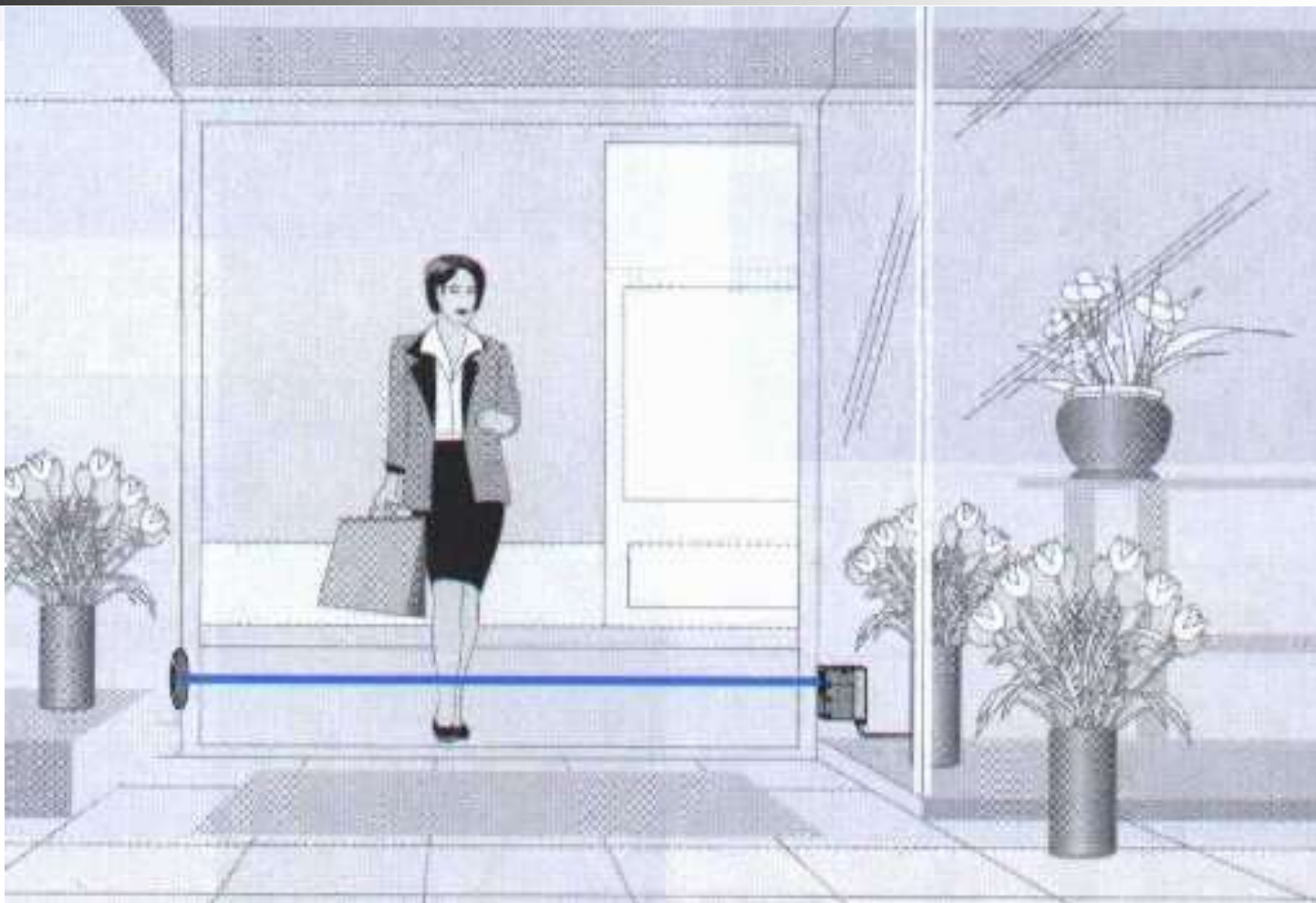

# Zona nadzora (kontrolne)

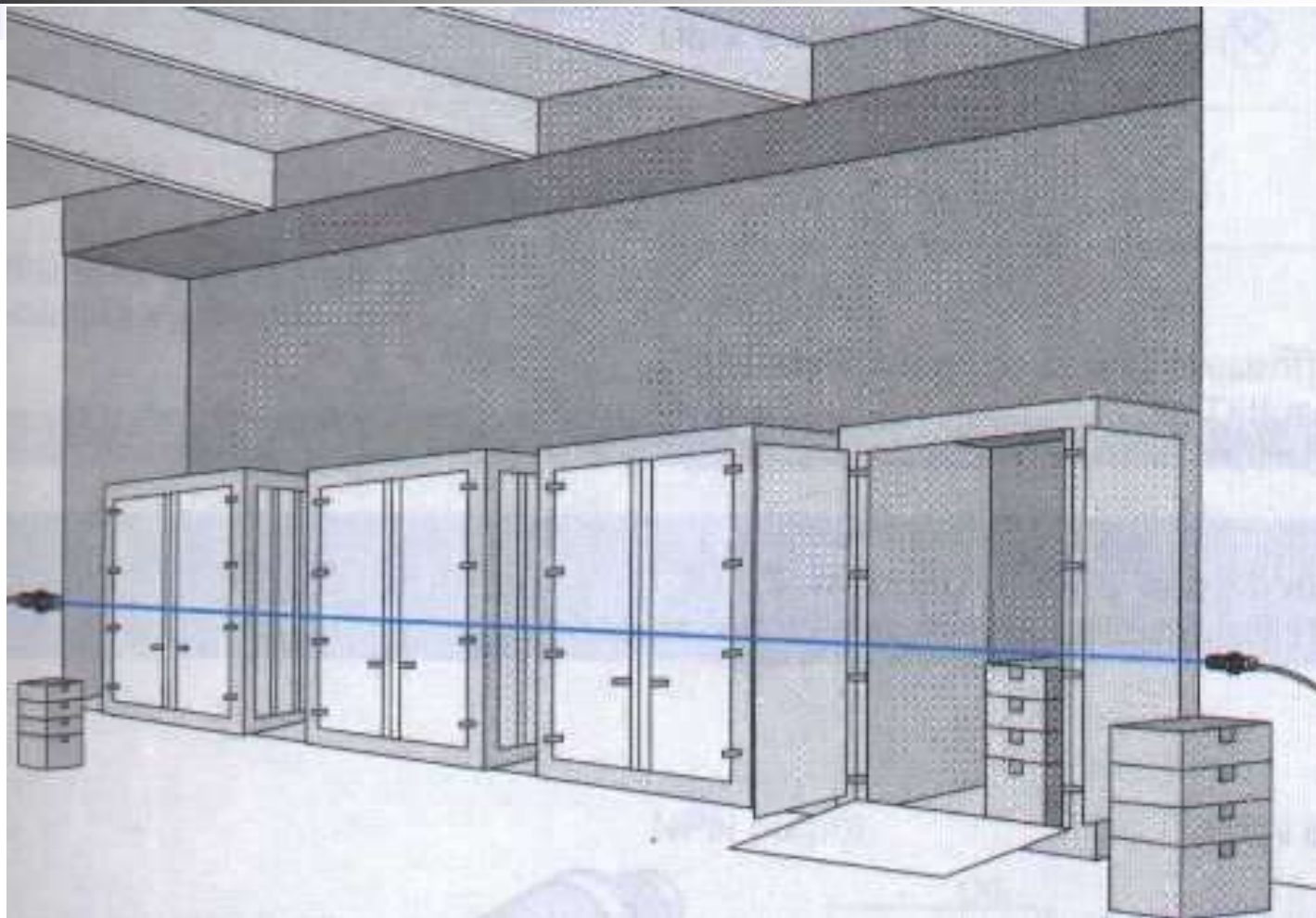

# Upravljanje garažnim vratima

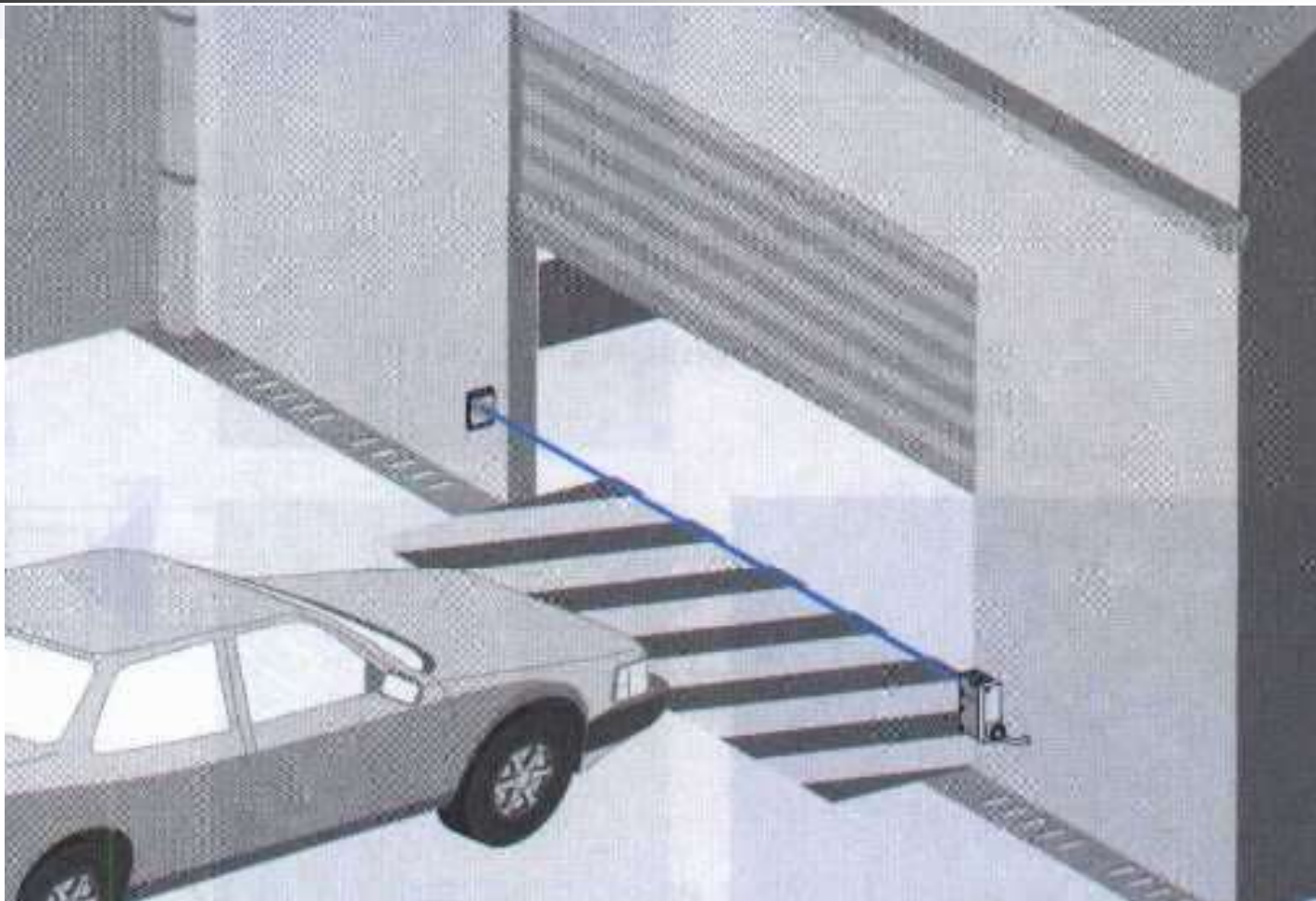

# Kontrola prolaska i brojanje flaša

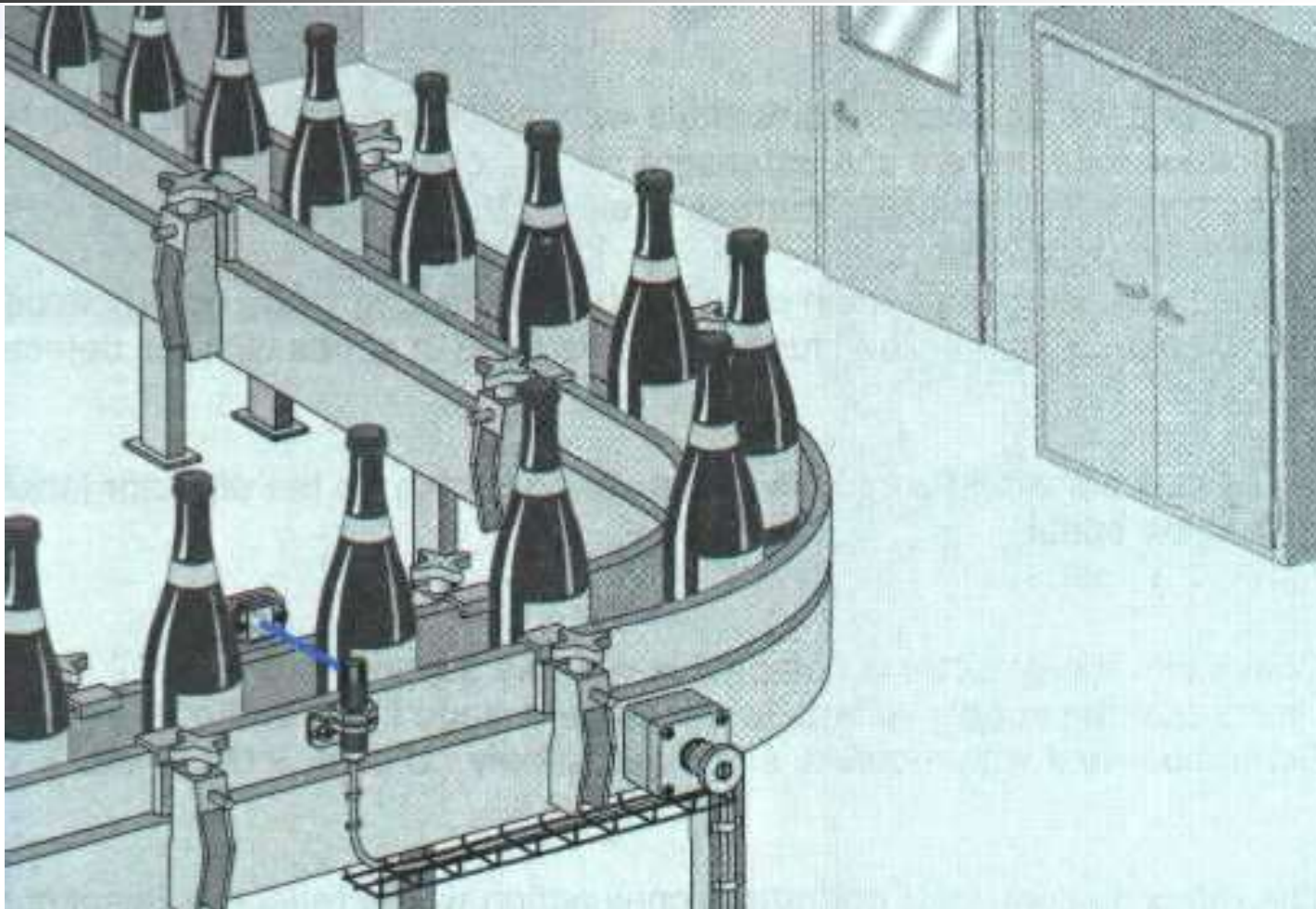



# Provjera napunjenosti ampula

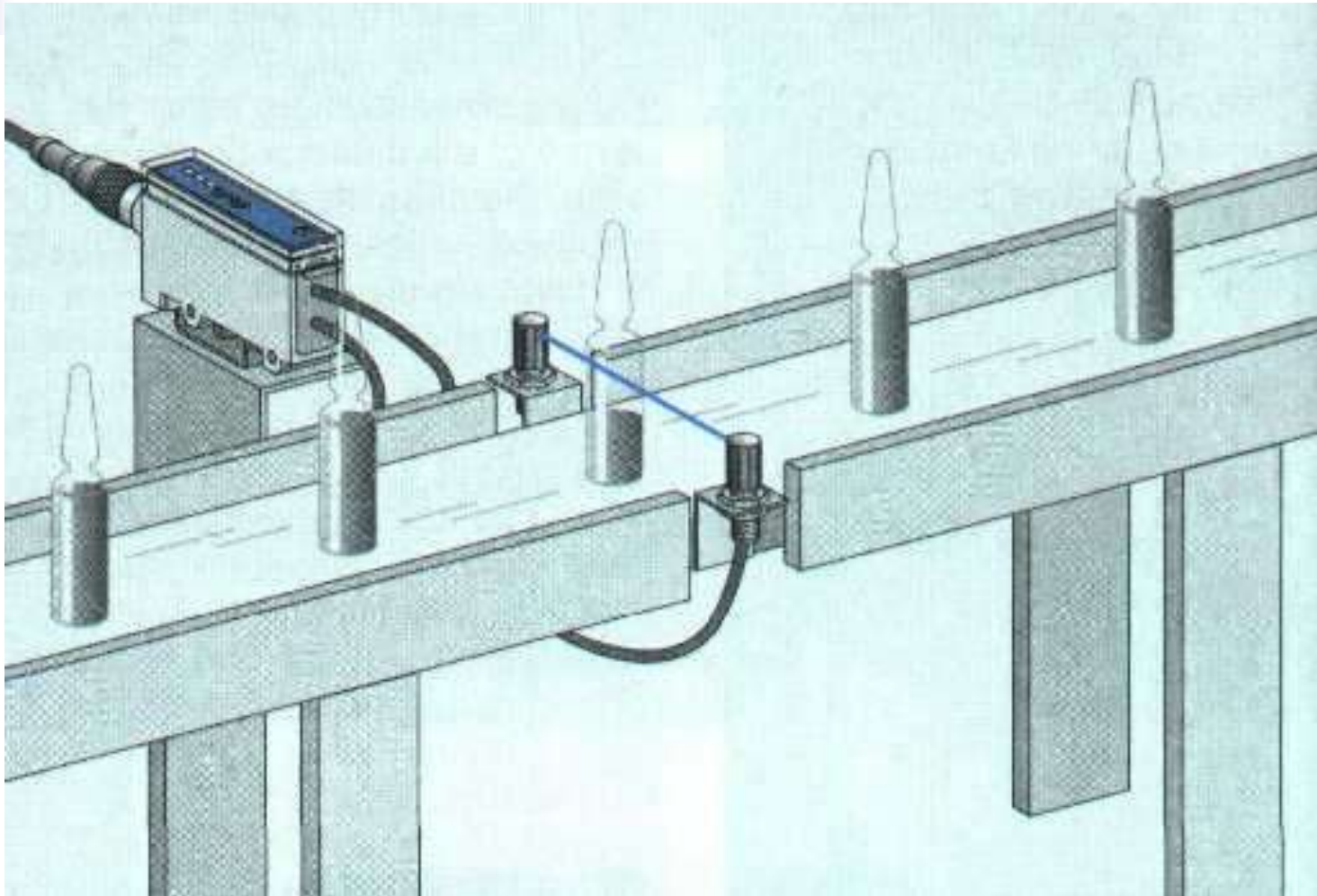

# Nadgledanje nivoa vode u posudama

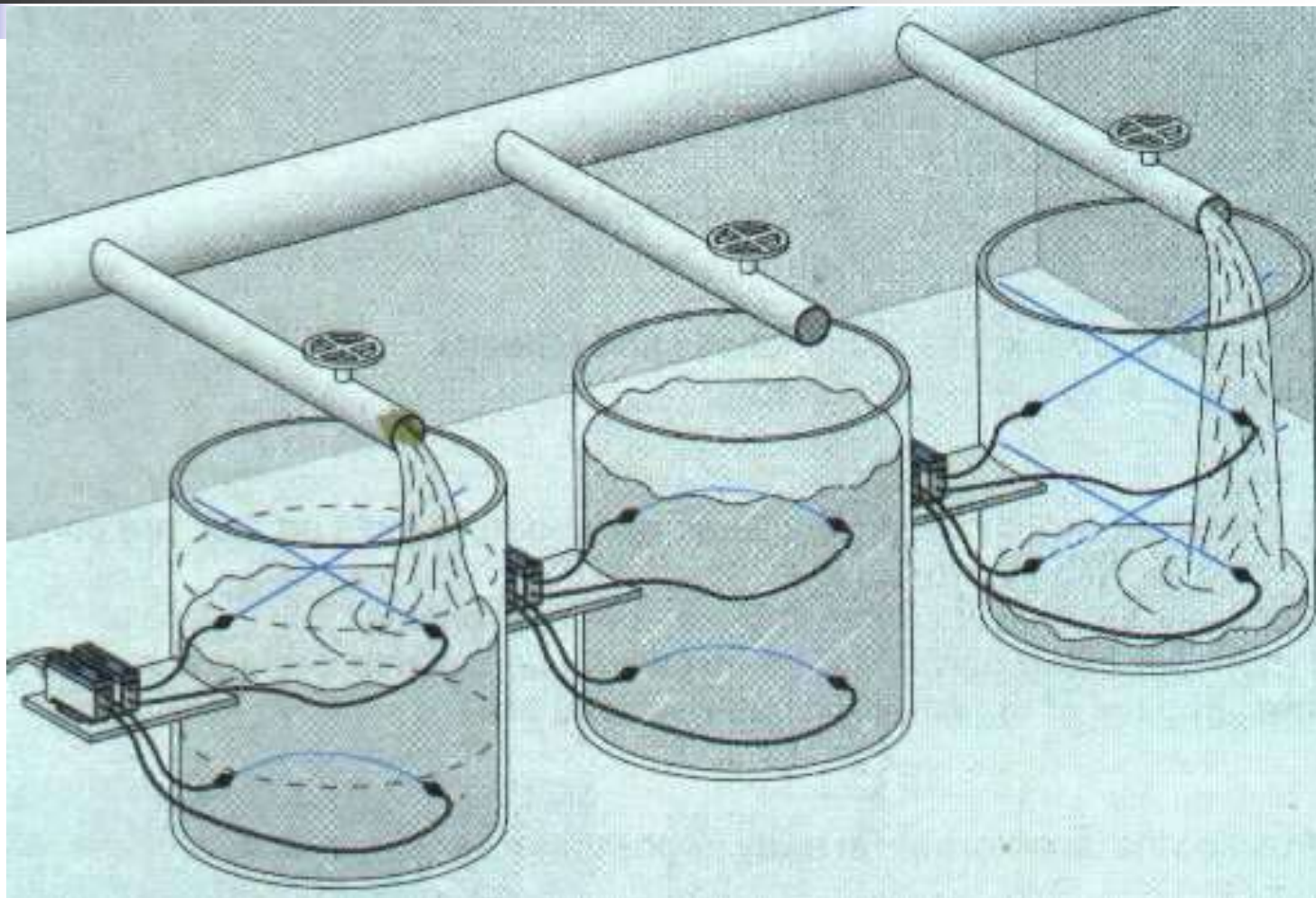

# Upravljanje pogonima u automatskoj auto-perionici

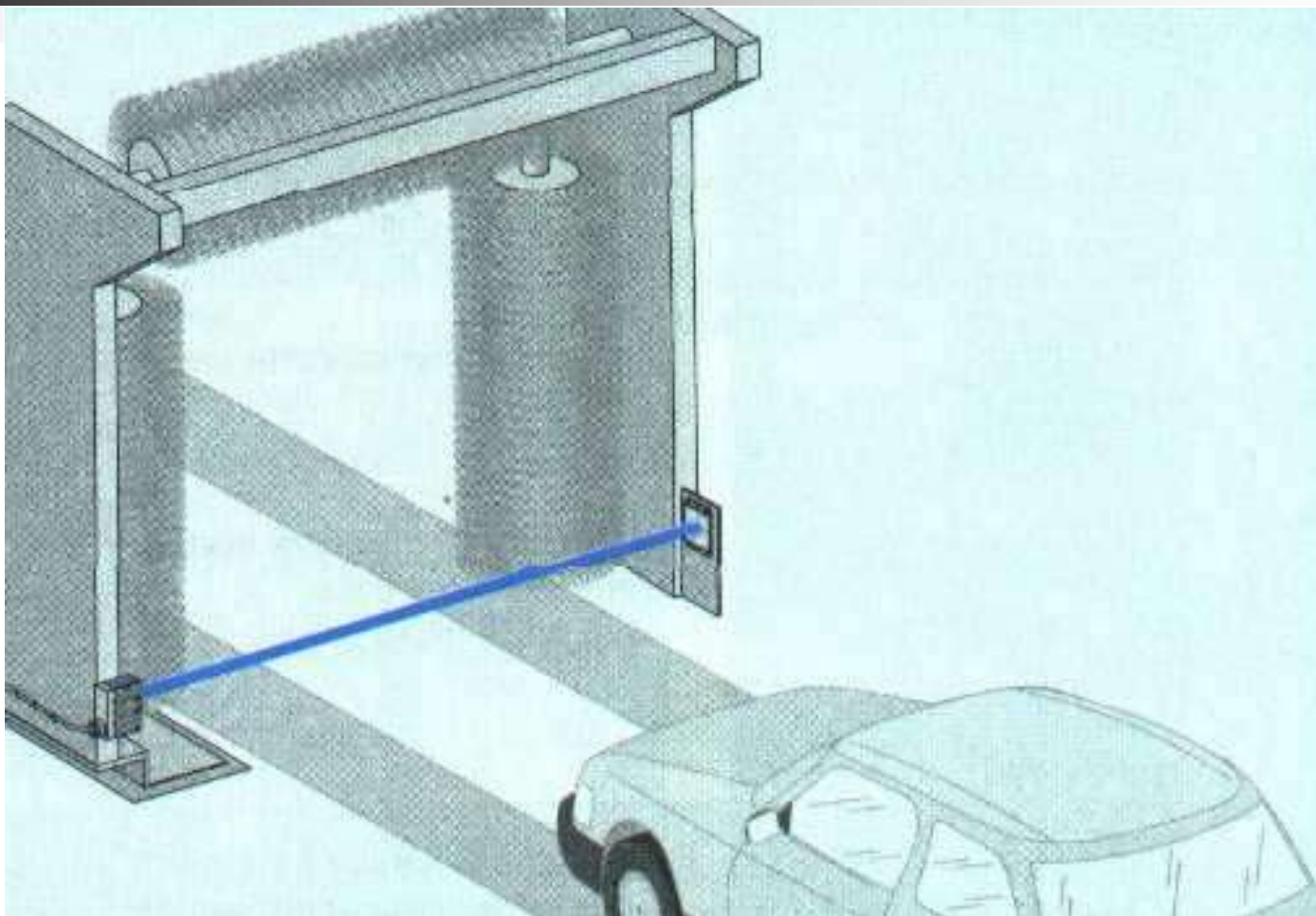

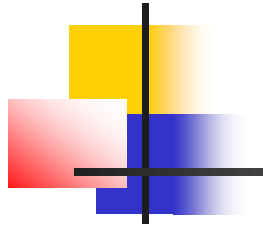

# Digitalni koderi i davači položaja



# Digitalni koderi i davači položaja

---

Oblast u kojoj su optički senzori dominantni.

Dva osnovna tipa digitalnih kodera su: **apsolutni** i **inkrementalni**.

Podjela koja se pravi prema vrsti pomaka: **linijski** i **ugaoni**.

Podjela prema smjeru kretanja:

**Jednokanalni** (ne prati smer kretanja);

**Dvokanalni** (daje informaciju o smeru kretanja).

# Apsolutni koderi

Apsolutni dekoderi daju jedinstven digitalni kod za svaku različitu poziciju objekta (osovine, vratila).

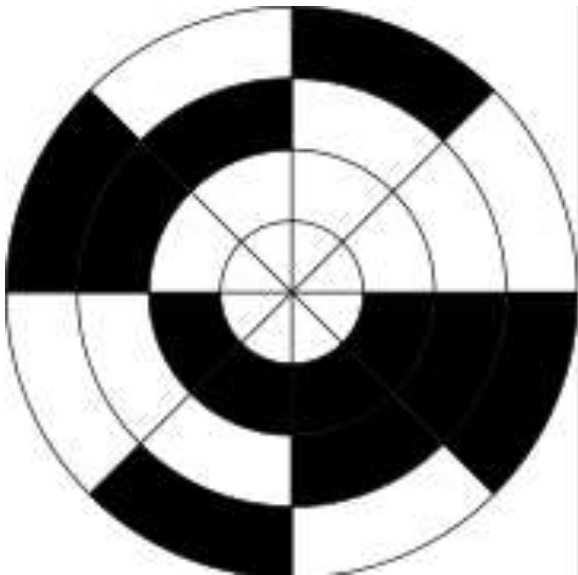

Sector	Contact 1	Contact 2	Contact 3	Angle
1	off	off	off	0° to 45°
2	off	off	on	45° to 90°
3	off	on	off	90° to 135°
4	off	on	on	135° to 180°
5	on	off	off	180° to 225°
6	on	off	on	225° to 270°
7	on	on	off	270° to 315°
8	on	on	on	315° to 360°

[Absolute encoder \(video clip 1\)](#)

[Absolute encoder \(video clip 2\)](#)



# Grey-ov kod (apsolutni koderi)

Dva susjedna stanja razlikuju se za po jedan bit.

	<u>B<sub>2</sub></u>	<u>B<sub>1</sub></u>	<u>B<sub>0</sub></u>		<u>G<sub>2</sub></u>	<u>G<sub>1</sub></u>	<u>G<sub>0</sub></u>
<b>a)</b>	0	0	0	<b>b)</b>	0	0	0
	0	0	1		0	0	1
	0	1	0		0	1	1
	0	1	1		0	1	0
	1	0	0		1	1	0
	1	0	1		1	1	1
	1	1	0		1	0	1
	1	1	1		1	0	0

Kombinacije tri bita: a) binarnom kodu i b) u Greyovom kodu.

$$G_2=B_2, \quad G_1=B_2+B_1, \quad G_0=B_1+B_0 \quad (\text{bez prenosa}),$$

# Grey-ov kod

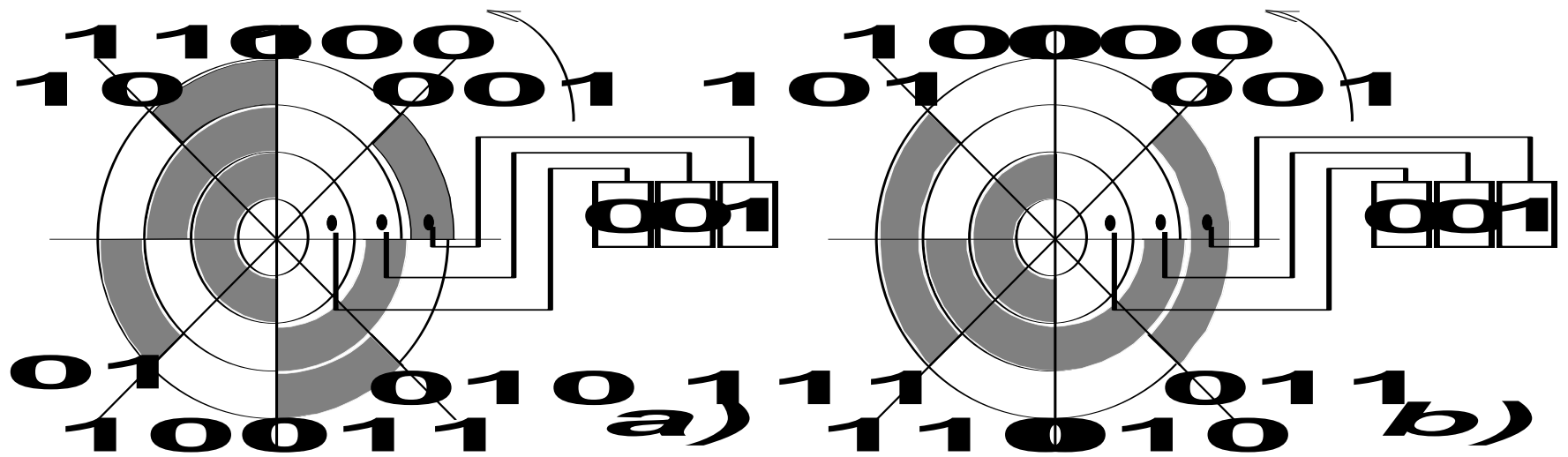

Dvije varijante diska za korišćenje 3-bitnog koda:

a) Prirodni kod; b) Greyov kod

[http://en.wikipedia.org/wiki/Grey\\_codes](http://en.wikipedia.org/wiki/Grey_codes)





# Incrementalni koderi

---

Rotary incremental encoder

Linear incremental encoder

# Inkrementalni koderi

Inkrementalni enkoderi imaju dva izlaza.

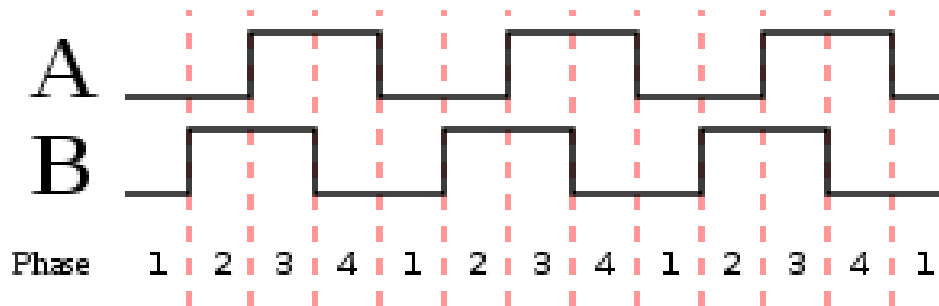

Gray coding for clockwise rotation

Phase	A	B
1	0	0
2	0	1
3	1	1
4	1	0

Gray coding for counter-clockwise rotation

Phase	A	B
1	1	0
2	1	1
3	0	1
4	0	0

# Inkrementalni davač sa zupčastim diskom

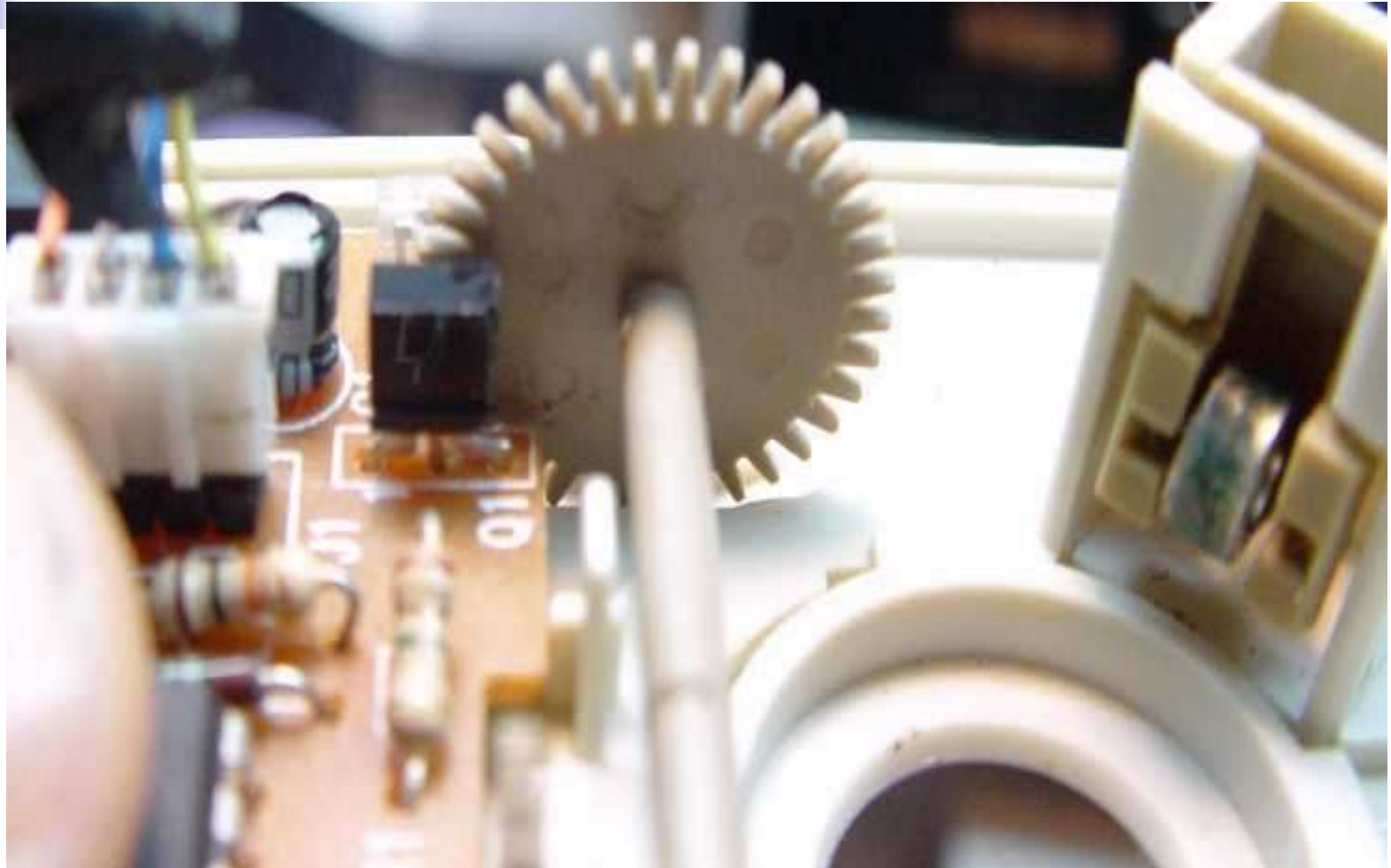

# Optički interfejs (inkrementalni davač)

```
x=PINB & 3; // čitamo stanje fototranzistora
```

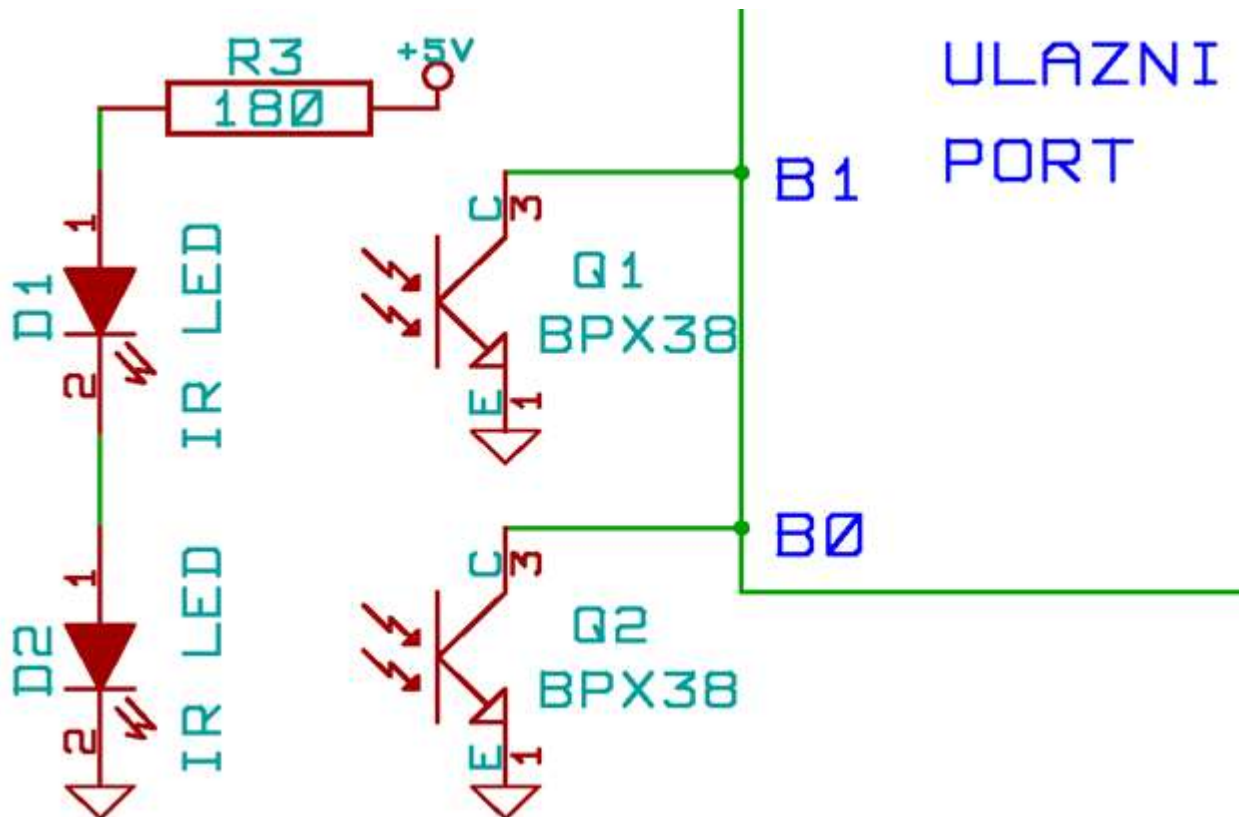

# Optički interfejs (optoelementi)

Infra LED

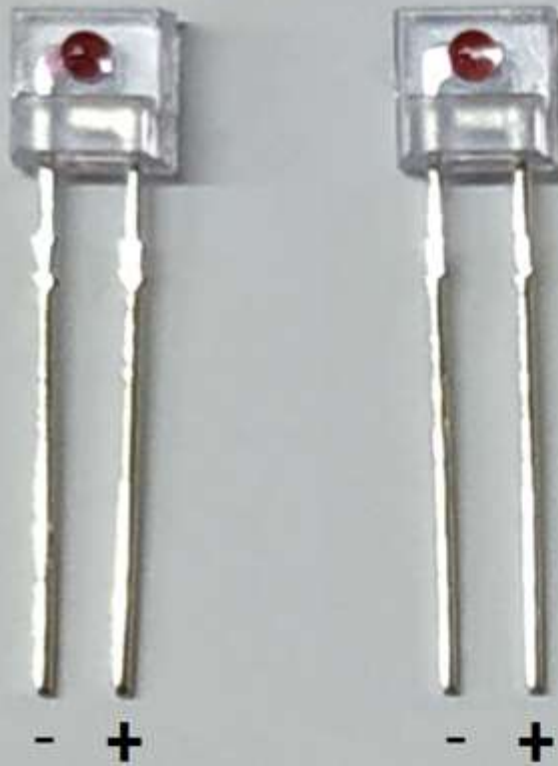

Fototranzistori

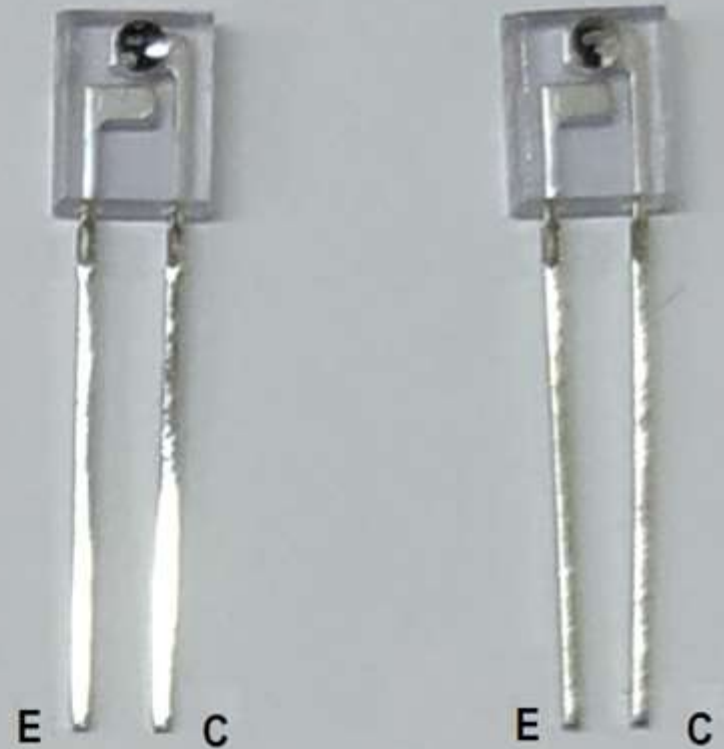

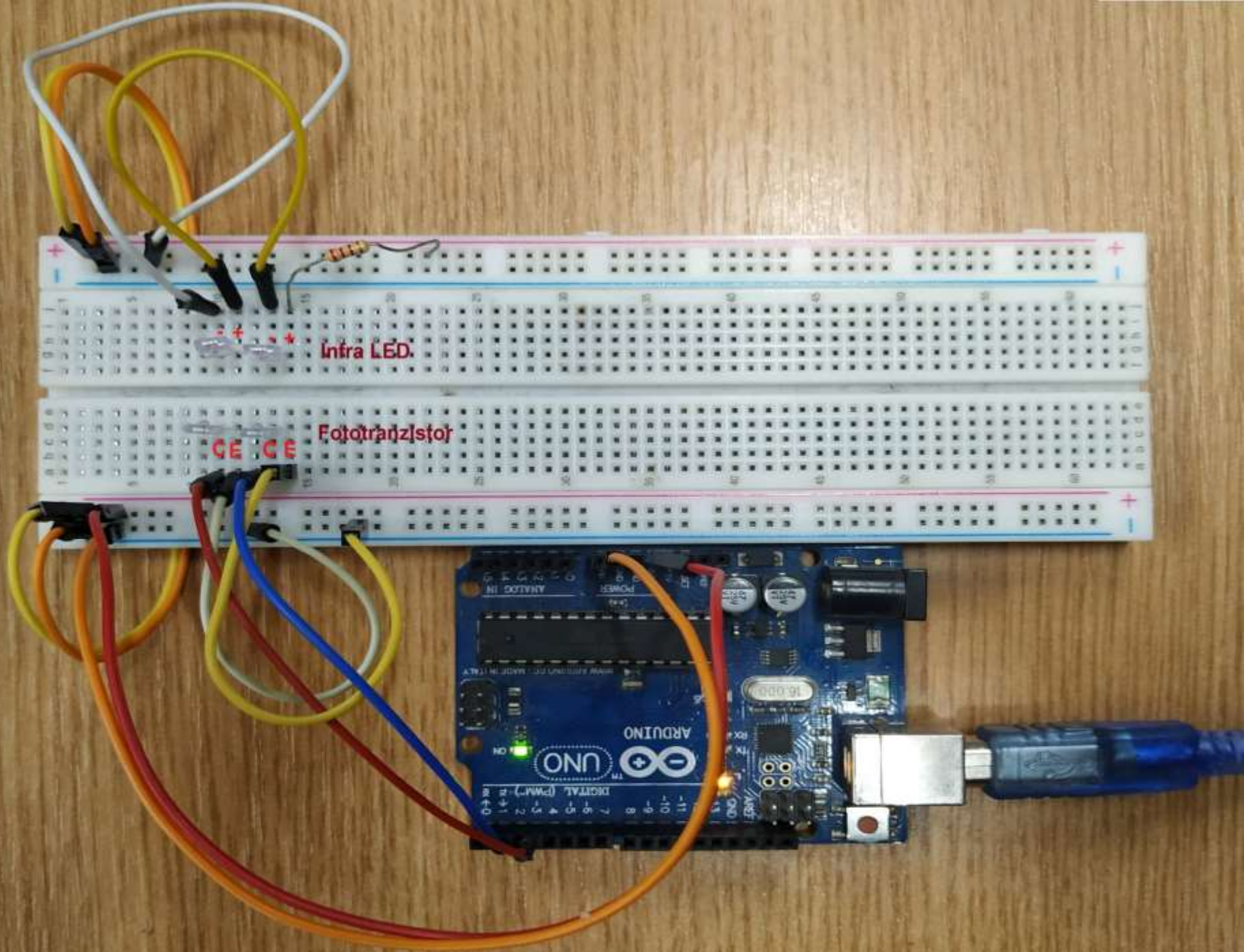

# Program za jednokanalni inkrementalni davač položaja

```
void loop()
{
  int y, staro;
  int novo=0,p=0;

  y = PINB;
  Serial.println(y);

  staro=novo;
  novo=y & 1;
  if (novo==staro) return;
  p++;
  Serial.println(p);
}
```

# Dijagram stanja – jedan smjer okretanja

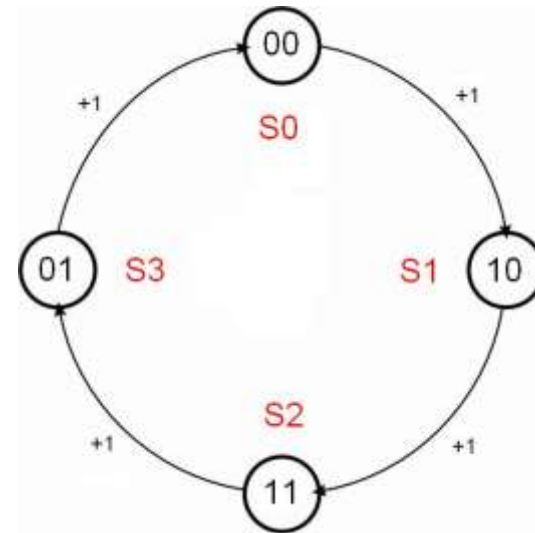
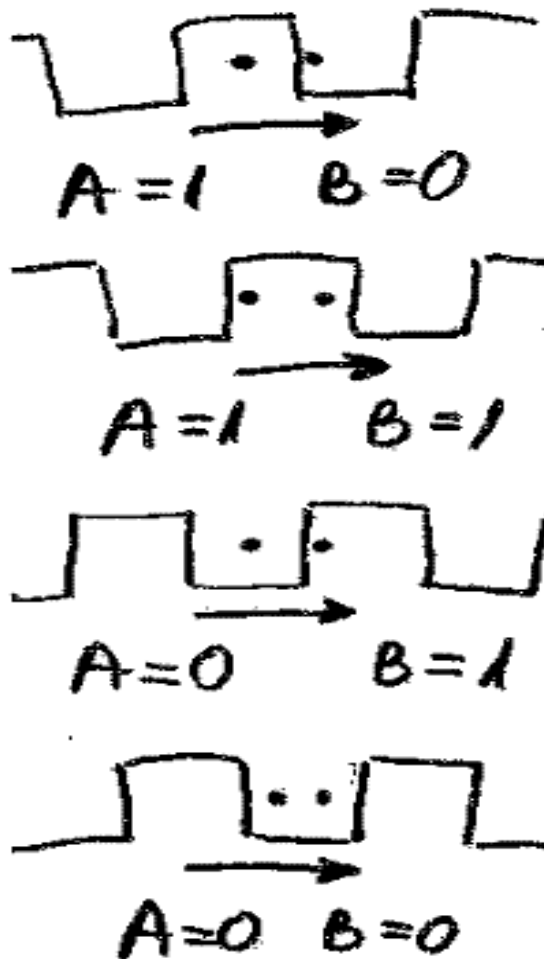

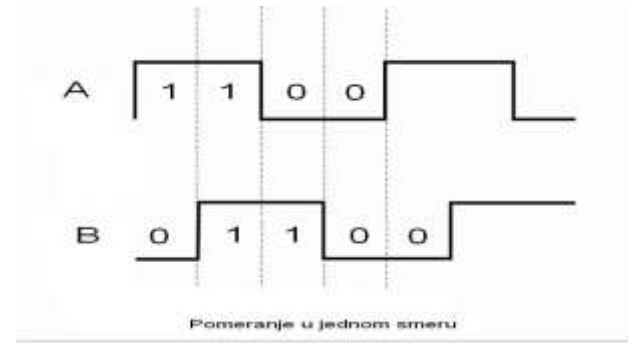

Pomeranje u pozitivnom smeru



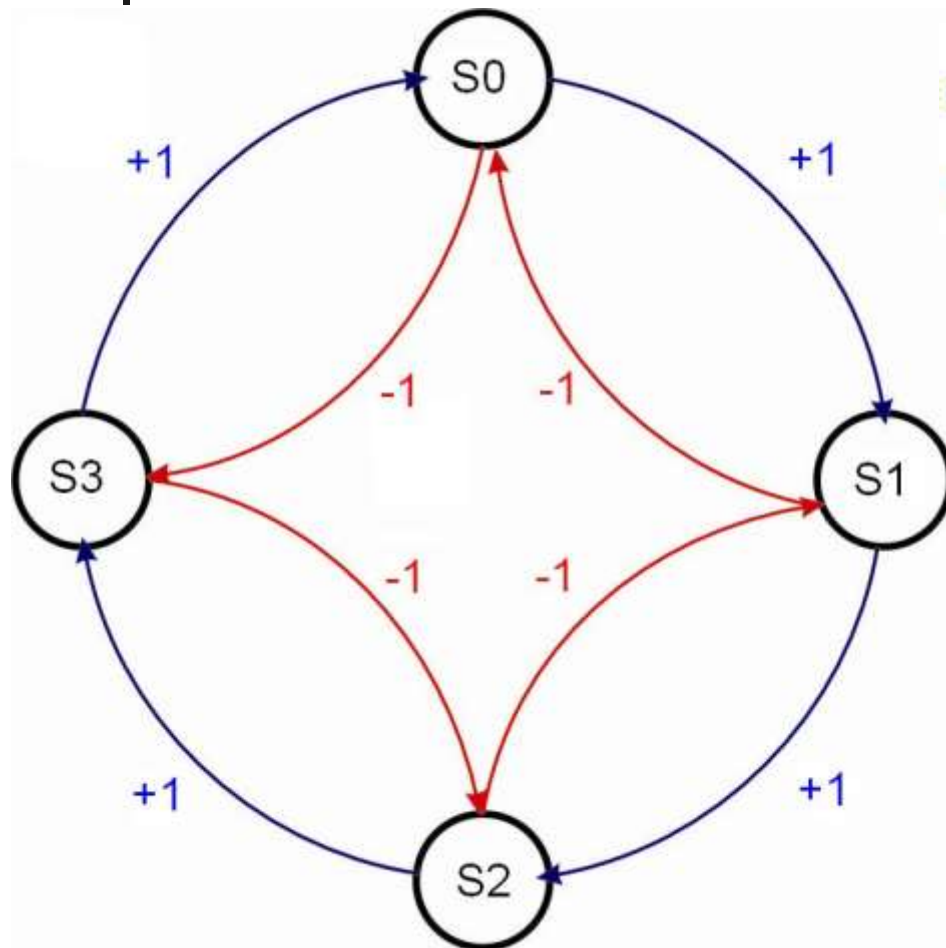

# Redosljed stanja za " +" i " - " smjer okretanja



-  pozitivan smer (inkrementiranje stanja)
-  negativan smer (dekrementiranje stanja)

# Razmak između optičkih kanala

Razmak između optičkih kanala ne mora biti tačno  $1/4$  periode zubaca. Jednako su dobri razmaci  $3/4$ ,  $5/4$ ,  $7/4$ , ...



$$A=0 \quad B=1$$



$$A=1 \quad B=1$$



$$A=1 \quad B=0$$

# Program za dvokanalni inkrementalni davač položaja

```
void loop()
{ #define S0 0 /*A=0 B=0*/
  #define S1 8 /*A=1 B=0*/
  #define S2 12 /*A=1 B=1*/
  #define S3 4 /*A=0 B=1*/

  int staro;
  static int novo=0, p=0;

  staro=novo;
  novo=PIND & 12;
  if (novo==staro) return;
```

```
    switch(staro){
      case S0: if(novo==S1) p++;
               if(novo==S3) p--; break;
      case S1: if(novo==S2) p++;
               if(novo==S0) p--; break;
      case S2: if(novo==S3) p++;
               if(novo==S1) p--; break;
      case S3: if(novo==S0) p++;
               if(novo==S2) p--; break;
    } /* kraj switch petlje */
    Serial.println(p);
```

```
  } /* Kraj programa*/
```



# Učestanost čitanja porta

---

Učestanost čitanja porta mora biti podešena tako da se svaka promjena stanja na portu registruje.

Ako je učestanost čitanja porta u odnosu na brzinu promjene stanja na ulazu u port preniska, svaka promjena neće biti registrovana. Tada ćemo imati preskoke stanja i dobićemo pogrešnu poziciju.

# X i Y inkrementalni davači (dva dvokanalna inkr. davača)

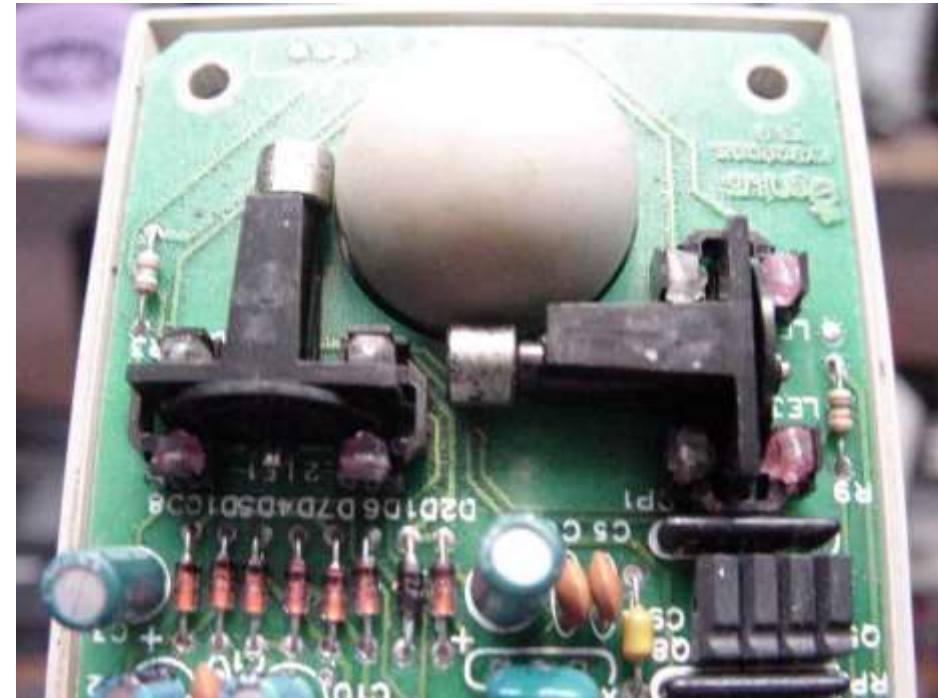

Iako se inkrementalni davači više ne koriste u miševima, u ostalim oblastima su nezamjenljivi. Koriste se za mjerenje položaja, linearne brzine, ugla, brzine obrtanja, i mjerenje svih veličina koje se mogu pretvoriti u pomjeraj kao što su težina, sila, pritisak, nivo, itd.

# Laserska mjerila sa inkrementalnim enkoderom



kljunasto mjerilo



mikrometar



tahometar

Laserski izvor svijetla omogućava inkrementalnom enkoderu više impulsa po jedinici dužine i preciznije mjerenje.



# Za vježbu

---

1. Realizovati dvokanalni inkrementalni davač sa praćenjem smjera kretanja, upotrebom prekida na Arduino digitalnim pinovima 2 i 3 (detalje o upotrebi prekida na digitalnim pinovima možete pogledati na stranici: <https://www.arduino.cc/reference/en/language/functions/external-interrupts/attachinterrupt/>). **(4-2)**
2. Brojanje proizvoda po smjenama. Porukom „PRVA“ sa serijskog monitora inicirati brojanje u prvoj smjeni. Porukom „DRUGA“ inicirati brojanje u drugoj smjeni. Porukom „TREĆA“ inicirati brojanje u trećoj smjeni. Na poruku „DAN“ odgovoriti prikazom na serijskom monitoru, koliko je izbrojano proizvoda po smjenama. **(4-2)**.
3. Pokret letve inicira okretanje koračnog motor. Promjena smjera kratanja letve, mijenja smjer okretanja koračnog motora. Ako se letvom napravi 12 ili više koraka u jednom smjeru zaustavlja se koračni motor. Pravljenje koraka u suprotnom smjeru pokreće koračni motor. Pomjeranje letve u istom smjeru ubrzava okretanje koračnog motora. **(4-2 boda)**